



EN

## ELECTRIC CONVECTOR HEATER

### FANCY

IP24

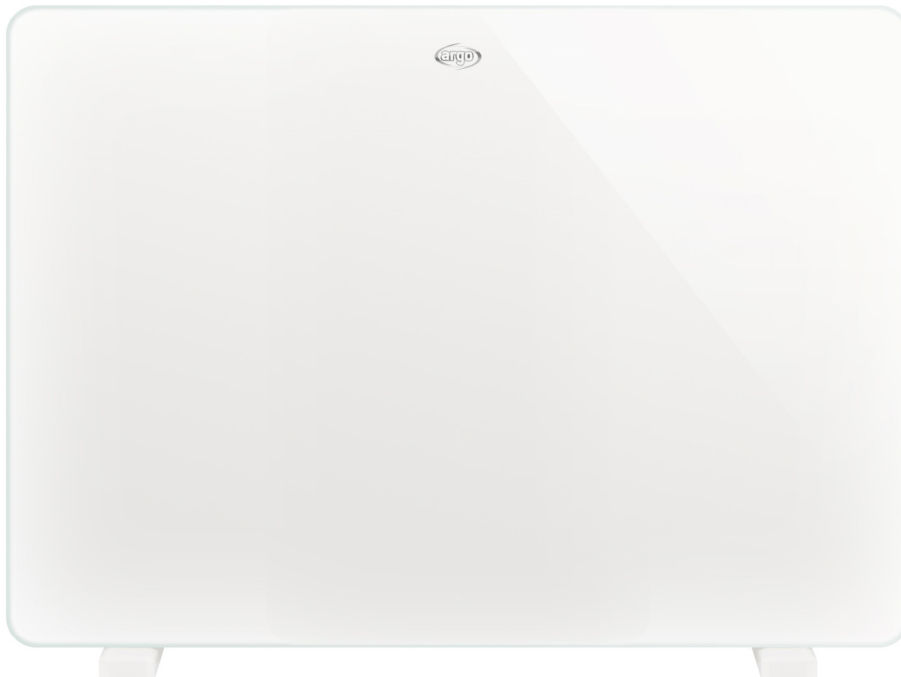

**This product is only suitable for well insulated spaces or occasional use.**

## OPERATING INSTRUCTIONS

Read the instructions carefully before installing and operating the appliance or performing maintenance operations. Observe all the safety instructions; failure to observe the instructions may cause accidents and/or damages. Store these instructions for future reference.

## GENERAL SAFETY INFORMATION

- Use this convector only as outlined in this manual. Any other use not recommended by the manufacturer may cause fire, electric shock or injury to persons.
- This convector is designed for domestic use. It must not be used for commercial or industrial purposes.
- Ensure that the mains voltage complies with that indicated on the convector data plate (230-240V~ 50-60 Hz).
- This appliance can be used by children aged from 8 years and above and people with reduced physical, sensory or mental capabilities or lack of experience and knowledge if they have been given supervision or instruction concerning use of the appliance in a safe way and understand the hazards involved.
- Children shall not play with the appliance.
- Cleaning and user maintenance shall not be made by children without supervision.
- Remove the convector from its packaging and check that it is in good condition before use. Keep any plastic bags away from children.
- Check the cord and plug before using the convector to ensure that they have not been damaged during transport.
- This product is not a toy.
- Children under the age of 3 must be kept away if not continuously supervised.
- Children aged between 3 and 8 must only turn the appliance on / off as long as it has been placed or installed in its normal operating position and that they receive surveillance or instructions regarding the safe use of the appliance and understand the dangers.
- Children between 3 and 8 years of age must not insert the plug, adjust or clean the appliance or carry out maintenance by the user.

**CAUTION - Some parts of this product can become very hot and cause burns. Particular attention has to be given where children and vulnerable people are present.**

**WARNING:** In order to avoid hazard due to inadvertent resetting of the thermal cut-out, this appliance must not be supplied through and external switching device, such as a timer, or connected to a circuit that is regularly switched on and off by the utility.

**WARNING: do not use the convector with a controller or any other external device that activates the appliance automatically,**

as there may be a risk of fire if the fan heater is covered or incorrectly positioned.

- The appliance is equipped with an IP24 degree of protection and can be used in private bathrooms in zone 2.

Do not use the convector in the immediate vicinity of bathtubs, showers, washbasins or swimming pools.

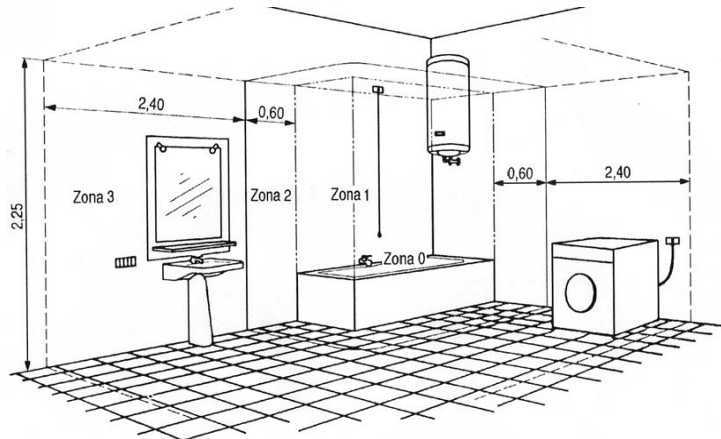

- Disconnect the mains power when the appliance is not used or for cleaning operations.
- To disconnect the convector, set the selector to 0 and remove the plug from the socket. Pull on the plug only. Do not pull the cord.
- Avoid placing fingers or foreign objects in the air inlet/outlet grilles, as this may lead to electric shock or fire and may damage the convector. To avoid the risk of fire, do not block the grilles or tamper with them in any way while the convector operates.
- **Do not use the convector if the cord or plug is damaged.** If the power cable is damaged, it must be replaced by the manufacturer or its technical assistance service or in any case by a person with a similar qualification, in order to prevent any risk.
- Do not place any objects on the cord and do not bend it. During operation, the cord must be entirely unwound.
- It is not advisable to use extension cords, as these may overheat and cause the risk of fire. Do not use a single extension cord to operate more than one convector.
- The convector heats up significantly during operation. Risk of burn. To avoid injury, do not allow skin to come into contact with a hot surface. Use the handle to move the convector. Keep flammable materials, such as furniture, cushions, blankets, paper, cloths, curtains and suchlike at least 1 m from the front and back

- Do not immerse the cord, plug or any other element of the panel in water or other liquids.
- Do not touch the plug or convector with wet hands.
- Avoid using the convector in dusty environments or in the presence of flammable vapors (e.g. in workshops or garages).
- Do not place the convector above or near another heat source.

**WARNING: AVOID COVERING THE CONVECTOR TO PREVENT IT FROM OVERHEATING.**

The symbol below signals the above warning:



- The convector may cause risk of fire if, while in operation, is covered by or comes into contact with **flammable** material including curtains, drapery, blankets, etc. **KEEP THE CONVECTOR AWAY FROM THESE MATERIALS.**
- Do not insert and avoid accidental insertion of any external objects into the ventilation or discharge outlets as this may lead to electric shock, fire or damage the convector.
- A convector contains parts that generate arcs or sparks. It must not be used in potentially dangerous areas such as areas at risk of fire or explosion, or areas loaded with chemical substances or humidity.
- Do not use the convector on soft surfaces such as beds, where the grilles may be covered. Always stand the convector on a flat, stable surface when in operation, in order to prevent it from overturning. Arrange the cord in such a way that the convector and other objects do not rest on it. Do not run the cord under carpets. Do not cover the cord with blankets, carpets or similar materials. Place the cord far away from busy areas, or in a place where it cannot be accidentally pulled-out.
- Never position the convector where it may fall into a bath or other containers of water.
- Never position the convector on a wet floor.
- In any case, the adjustment switches must never be accessible by anyone in a bath or shower.
- The heating appliance must not be positioned immediately below a power outlet.
- The socket must be earthed.

- Do not allow the electric cord to touch the metal structure of the convector when it is hot or in operation, in order to avoid the high temperatures ruining the cord.
- Do not operate the convector outdoors. Do not use the convector in front of or near an open window.
- **WARNING: do not use the convector with an external controller or any other external device that activates the convector automatically, as there may be a risk of fire if the convector is covered or incorrectly positioned.**
- Upon initial start-up, the convector may emit a slight, harmless smell. This smell is a normal effect of the initial heating up of the internal heating elements, and should not recur later on.
- Do not attempt to repair, disassemble or modify the convector. The convector does not contain parts that can be repaired by the user.
- Turn the switch off and unplug before carrying out any maintenance work or moving the convector. Always unplug from the socket when the convector is not in use.
- **WARNING: ALWAYS UNPLUG WHEN CARRYING OUT MAINTENANCE WORK OR MOVING THE CONVECTOR.**
- Do not place anything on the convector; avoid placing wet garments on the convector.
- Turn the appliance off if unattended in order to avoid accidents.
- If the convector is not used for prolonged periods, disconnect the plug, replace the convector in its box and store it in a dry, ventilated place.
- Ensure that the air inlet /outlet are not close to walls or curtains when the convector is in use, so as to avoid obstructing the convector and hampering its efficiency.
- Should you hear an abnormal noise or detect an unusual smell when using the convector, cease use and unplug immediately.
- Do not expose the elderly or children to a continuous flow of air.
- Do not use the convector if it has been damaged or dropped.
- Always use the convector with feet fixed. Do not use any other feet except the ones supplied with the product.

**WARNING: THE ON/OFF SWITCH IS NOT THE ONLY MEANS TO DISCONNECT THE POWER SUPPLY. ALWAYS PULL OUT THE PLUG FROM THE SOCKET IN THE EVENT OF MAINTENANCE OPERATIONS, WHEN MOVING THE PANEL OR WHEN NOT IN USE.**

## DESCRIPTION OF PARTS

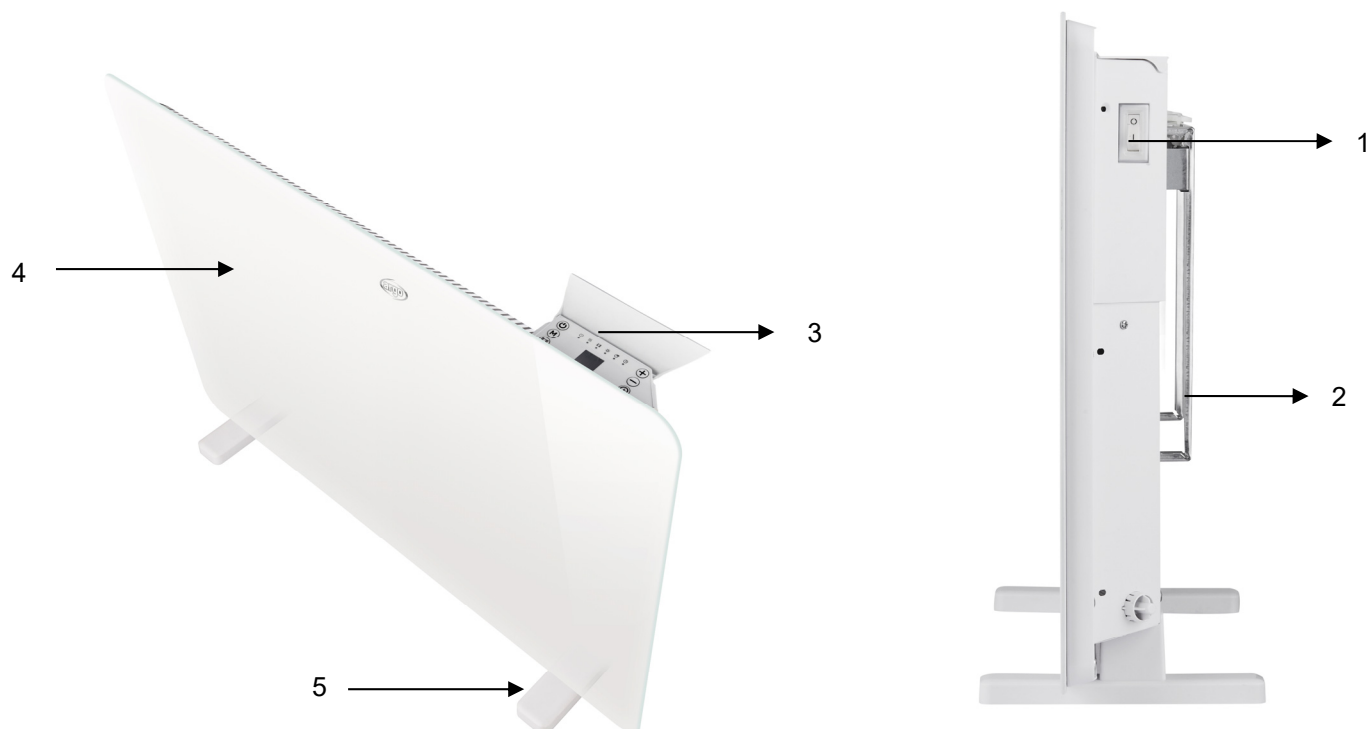

1. ON/OFF switch
2. Rear bracket
3. Control panel
4. Front panel
5. Feet

## HOW TO INSTALL THE APPLIANCE

The convector can be used on the floor, after assembling the feet, or alternatively it can be wall-mounted using the specific accessories supplied.

### A. Floor portable using: how to assemble the feet supplied

The convector is packed without feet. These must therefore be assembled before using the appliance.

Assemble the feet as shown in the figure and put the convector in an upright position. Position the unit on a flat, stable surface and follow the indications here below:

1. Turn the convector upside down

2. Insert the feet. The longest part must be positioned behind on the rear the convector.

3. Tighten the wing nuts on the feet.

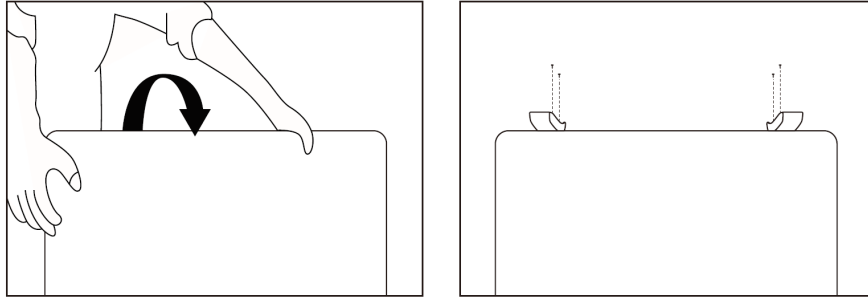

### B. Wall-mounting: how mount the convector onto the wall

The convector packaging contains all the accessories necessary for wall-mounting.

To wall-mount, proceed as follows. The appliance has already attached the bracket to the rear of the product, so remove it from the convector following these steps:

1. Unscrew the two screws located on the upper part of the two vertical bars of the wall bracket.
2. Pull out the wall bracket by pressing down on the top of the two vertical bars of the wall bracket.
3. Remove the wall bracket completely from the convector.

After removing the bracket, proceed as follows (figure below):

- A. By placing the bracket against the wall, mark on the wall with the pencil the points where to make the holes to insert the fisher. Respect the minimum distances of the convector from the walls.
  - B. Drill the 8mm diameter holes in the wall and insert the fisher.
  - C. Attach the bracket to the wall and screw the supplied screws into the fisher.
  - D. Position the unit straight so that the holes are aligned with the bracket and insert the parts of the bracket into the holes on the back in the upper part of the convector. Make sure that the convector is firmly hooked to the bracket by gently pulling it.
- Tighten the screws at the top of the convector firmly.

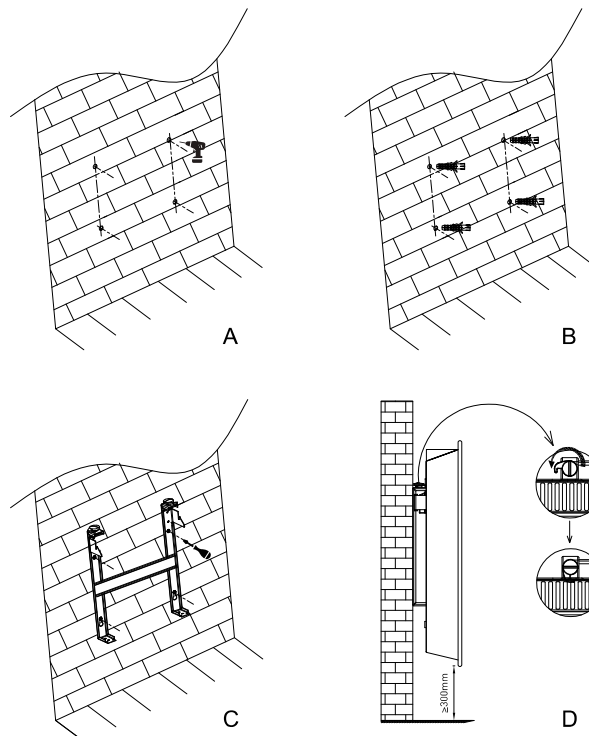

Make sure that the convector is placed at least 30 cm from the floor and that the distance from walls and objects is respected, as indicated in the figure below:

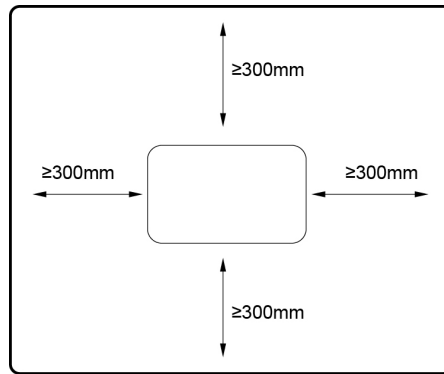

## CONTROL PANEL

### TOUCH CONTROL PANEL ON THE UNIT

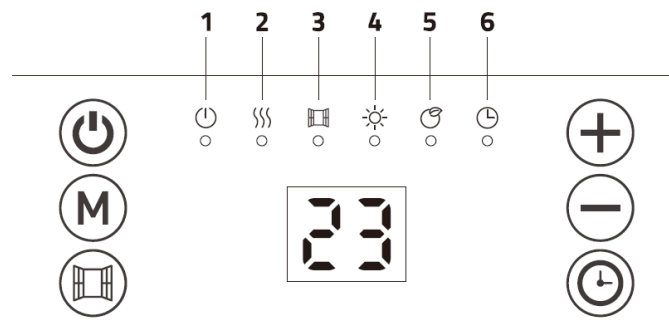

#### LED ON CONTROL PANEL

- ① Standby: on/off
- ② Heating Mode
- ③ Open window function
- ④ Comfort Mode
- ⑤ ECO Mode
- ⑥ Timer

#### OPERATIVE BUTTONS ON CONTROL PANEL

	Standby
	Heating Mode
	Open window function
	Button +
	Button -
	Timer

Connect the power cord to an appropriate power outlet (230-240V / 50-60Hz).  
The appliance emits a beep, this means that the convector is ready for use.

The LED lights up on the control panel.

Then press the ON / OFF switch located on the side of the unit and move the button to position I to turn on the device. If, on the other hand, you want to switch off the convector, turn the button to position O.





## ON / OFF - STAND-BY BUTTON



After connecting the power cable and turning on the unit with the side power button, press this button on the control panel to turn on the fan heater. Press this button again to turn off the appliance.

## TIMER BUTTON AND WEEKLY SETTING



Press and hold this button on the control panel for 3 seconds to select the timer and weekly setting. The display shows "d", then press the and keys to select the days of the week in the following sequence:

1	Monday
2	Tuesday
3	Wednesday
4	Thursday
5	Friday
6	Saturday
7	Sunday

Press the button  to confirm the desired day and set the time, the display will show 

Then press  and  buttons to select the hour, then press the button  to confirm it.

Appears on the display 





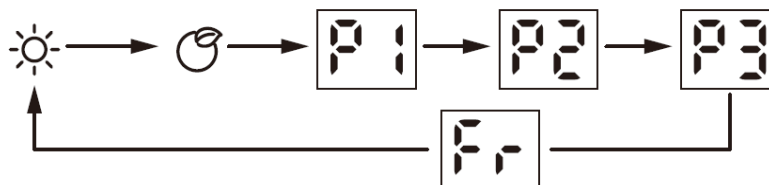

Press  and  buttons to set the minutes, then press the button  to confirm.

NB: If the power supply is removed, the weekly programming and the timer are reset to the factory settings.

## HEATING MODE BUTTON

Press this button on the control panel to activate the heating modes, in the following circular sequence:



-  Comfort Mode: Press the buttons  and  to set the temperature from 5°C to 35°C
-  ECO Mode: Press the buttons  and  to set the temperature from 1°C to 31°C
-  Anti-frost Mode: The target temperature is 7°C. The temperature can't be adjusted.
- P1/P2/P3 Pre-set heating program
- Note: If the clock and day setting are not finished, the first time to enter P1/P2/P3 program setting, it is requested to set day and clock setting in advance.

P1: (Monday-Sunday) Unadjustable program



P2: (Monday-Friday) Unadjustable program



P2 : (Saturday-Sunday) Unadjustable program

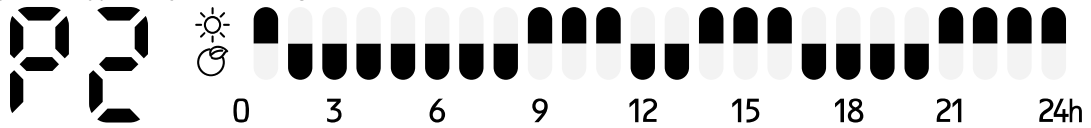

P3: (Monday-Friday) Adjustable program



P3:(Saturday-Sunday) Adjustable program



- P3 adjustable program setting

1. When under P3 mode, press **M** over 3 secs to enter day setting.

2. The screen displays **d1**, press **+** and **-** to set from **d1-d7** (Monday-Sunday). Press **M** to confirm and enter hour setting

3. The screen displays **00**, press **+** and **-** to set from 00-23). Press **M** to choose heating mode for every hour (Comfort mode or ECO mode )

4. Repeat the operation until you have completed the schedule of every hour and every day.

Note: After setting heating mode for hour 23, press **+** to come back to day setting.

Note: when screen displays **d7**, press **+** finish all setting with display of **P3**.

## OPEN WINDOW FUNCTION

Press one time and the indicator light is on. If open window function is activated, the indicator light keeps flashing and stops heating.

Press again to quit open window function and back to previous working situation.

## TIMER OFF BUTTON

Press one time, the indicator light is on. And the screen display "0 H" and keeps flashing. press **+** and **-** to set timer from 0-24 hours. Press again to confirm setting.

## MAINTENANCE AND STORAGE

**ALWAYS UNPLUG THE APPLIANCE BEFORE CLEANING OR MAINTENANCE.  
IMPORTANT: DO NOT SUBMERGE THE CONVECTOR IN WATER.**

### **Cleaning the outside surface of the appliance**

Turn the switch off and unplug before carrying out any maintenance work or moving the appliance.

Use a soft cloth to remove any dust from the convector.

If the convector is excessively dirty, use a soft cloth moistened with water and a mild detergent at a temperature lower than 50°C. Let the convector dry completely before use.

Do not use corrosive detergents or solvents such as petrol. Do not wash the appliance with water. Do not use oils, chemical substances or other items to clean that may damage the surface.

Use a vacuum cleaner to remove dust from the air inlet/outlet grilles.

### **STORAGE**

If the appliance is not used for prolonged periods, it must be stored together with this manual in its original packaging, in a cool and dry place.

Table 2

**INFORMATION REQUIREMENTS FOR ELECTRIC LOCAL SPACE HEATERS**

Annex II - Ecodesign requirements - Requirements for product information -  
 COMMISSION REGULATION (EU) 2015/1188 of 28 April 2015 implementing Directive 2009/125/EC of the European Parliament and of the Council with regard to ecodesign requirements for local space heaters

Model identifier(s): FANCY			
Item	Symbol	Value	unit
<b>Heat output</b>			
Nominal heat output	$P_{nom}$	1,40	kW
Minimum heat output (indicative)	$P_{min}$	1,40	kW
Maximum continuous heat output	$P_{max,c}$	1,40	kW
<b>Auxiliary electricity consumption</b>			
At nominal heat output	$e_{lmax}$	NA	kW
At minimum heat output	$e_{lmin}$	NA	kW
In standby mode	$e_{lsb}$	0,0004	kW
<b>Type of heat input, for electric storage local space heaters only (select one)</b>			
manual heat charge control, with integrated thermostat			[no]
manual heat charge control with room and/or outdoor temperature feedback			[no]
electronic heat charge control with room and/or outdoor temperature feedback			[no]
fan assisted heat output			[no]
<b>Type of heat output/room temperature control (select one)</b>			
single stage heat output and no room temperature control			[no]
Two or more manual stages, no room temperature control			[no]
with mechanic thermostat room temperature control			[no]
with electronic room temperature control			[no]
electronic room temperature control plus day timer			[no]
electronic room temperature control plus week timer			[yes]
<b>Other control options (multiple selections possible)</b>			
room temperature control, with presence detection			[no]
room temperature control, with open window detection			[yes]
with distance control option			[no]
with adaptive start control			[no]
with working time limitation			[yes]
with black bulb sensor			[no]
Seasonal space heating energy efficiency (portable appliance)		$\eta_s(\%)$	38
Seasonal space heating energy efficiency (fixed appliance)		$\eta_s(\%)$	39
Contact details :	ARGOCLIMA SPA - Via A. Varo,35 - Alfianello (BS) - ITALY - www.argoclima.com		



**Information for correct disposal of the product in accordance with the European Directive 2012/19/EU**

At the end of its working life this equipment must not be disposed of as an household waste. It must be taken to special local community waste collection centres or to a dealer providing this service. Disposing of electrical and electronic equipment separately avoids possible negative effects on the environment and human health deriving from an inappropriate disposal and enables its components to be recovered and recycled to obtain significant savings in energy and resources. In order to underline the duty to dispose of this equipment separately, the product is marked with a crossed-out dustbin.



improve your life

[www.argoclima.com](http://www.argoclima.com)