

YABER

型号:K2s 投影仪

Type:快速指引(合订)

材质:铜版纸105g, 封面封底157g过哑油

尺寸:130*160mm

设计师:Samuel

颜色:单色印刷

工艺:钉装, 正反面印刷

日期:2023/03/30

Yaber

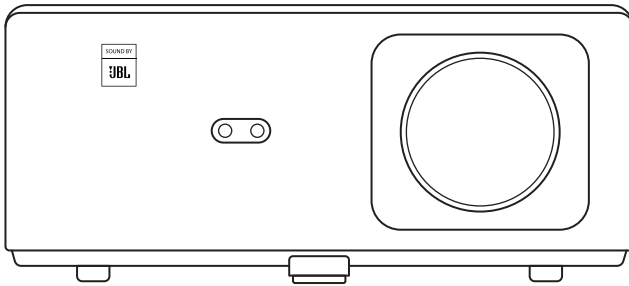

Quick Start Guide

Smart Projector K2s **EN**

Package Contents

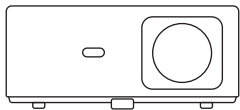

K2s Projector

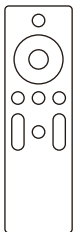

Projector Remote Control

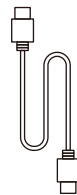

HDMI Cable

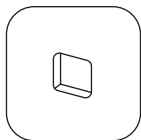

TV Dongle



TV Dongle Remote Control

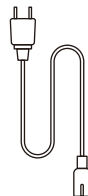

Power Cord

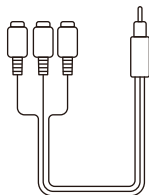

3-in-1 AV Cable



Quick Start Guide

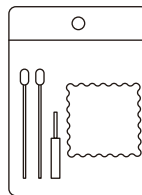

Cleaning Kits



Yaber Lens Cover

Product Overview

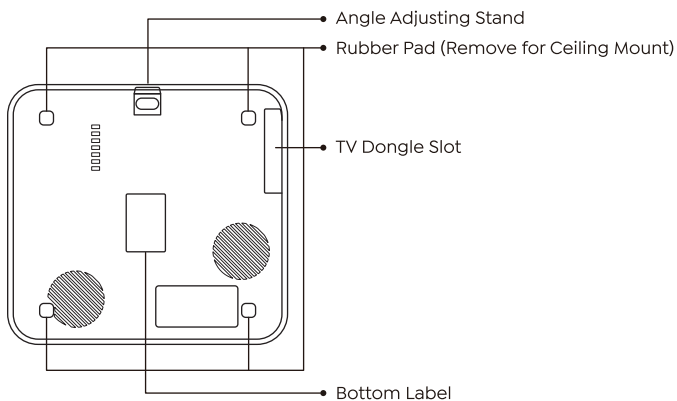
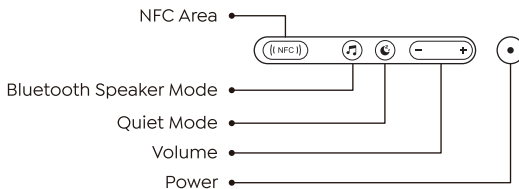
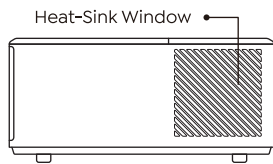
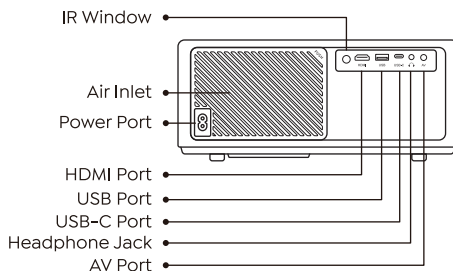
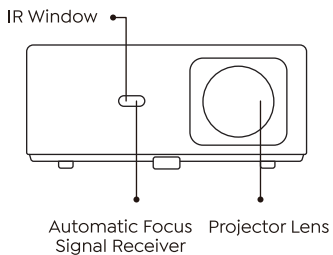

Install the TV Dongle

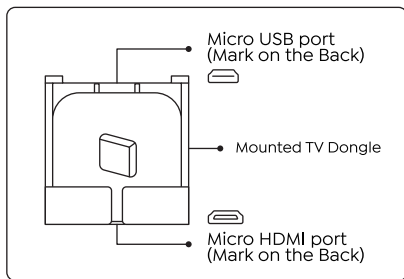
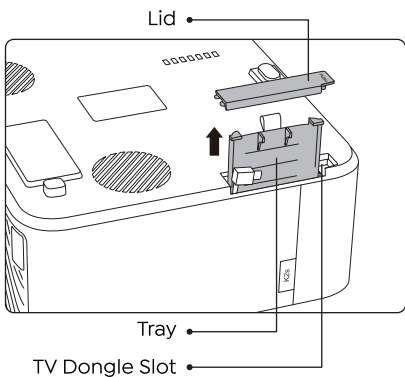

1. Push once to open the lid, and take out the tray.
2. Mount the TV Dongle and make sure the Micro HDMI port downside and the Micro USB port upside.

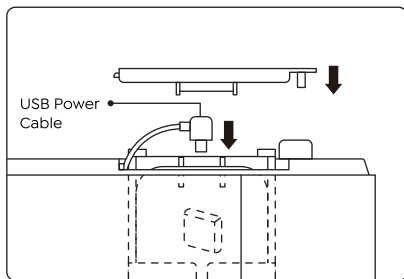
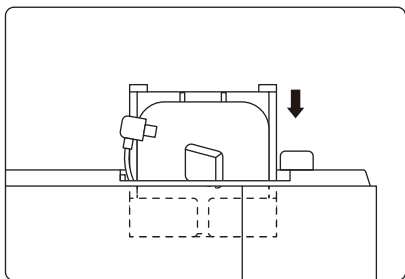

3. Insert the mounted TV Dongle into the slot.
4. Plug the USB power cable into the Micro USB port, and push to close the lid.

Alexa Smart Voice Control Setup

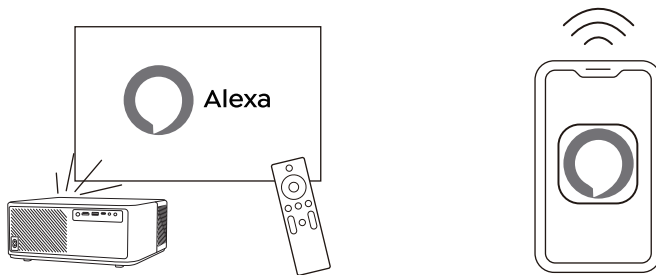

1. Connect K2s to the Wi-Fi network and start Alexa Setup from the projector home screen and log in with your Amazon account.

2. Open Alexa on your phone and log in with your Amazon account. Go to More--->Skills & Game, and search for Skills--->Find Whale Video and enable it.

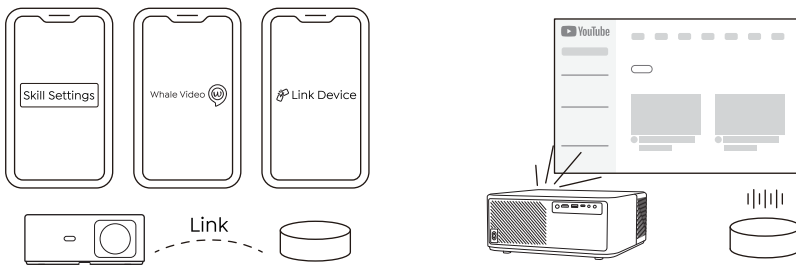

3. In Whale Video Settings--->Advanced Settings page, pair your projector with your smart speakers (built-in Alexa) to finish your setup.

4. Now try this“Alexa, open YouTube on the projector.”

Turn on Yaber Projector

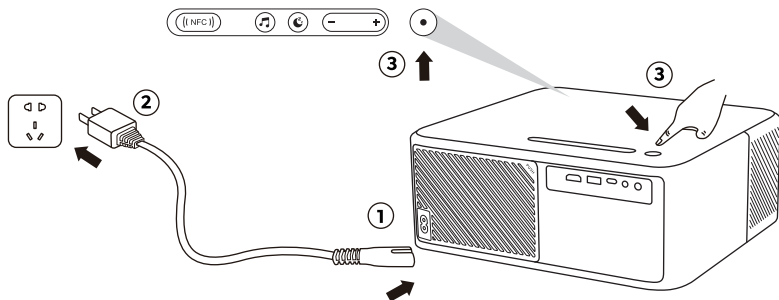

Connect Devices

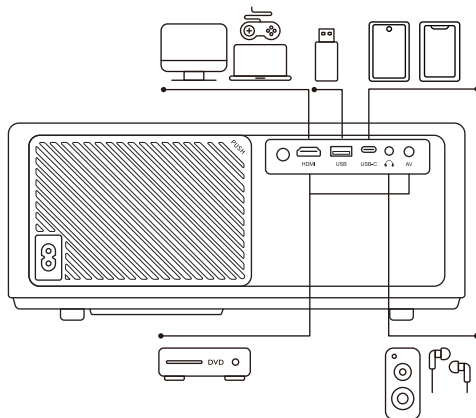

Yaber K2s projector has 5 ports, HDMI port/USB port/USB-C port/AV_in/Audio out. Please select the correct connecting port to connect your devices. (PC, Phone, DVD Player, Bluetooth Speaker, USB)

NFC Settings

1. Download and install E-share App by scan QR code or visit <http://h.eshare.app>
2. Make sure your phone and projector are connected to same network, and connect the projector on E-share App.

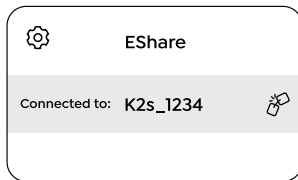
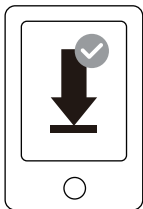

3. Go to Settings on E-share App, Select "Write NFC Tags" and follow the prompts to activate the NFC area on the projector.
4. Now you can tap your phone closely on the NFC area to Screencast while the projector is powered on and on the same Wi-Fi network as your phone.

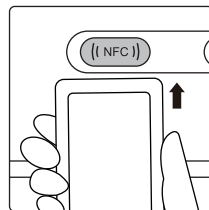
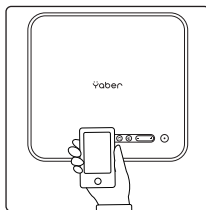
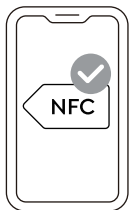

Note:

1. NFC screencast requires your phone to touch the NFC detection area on the projector, which may not be suitable for ceiling mounts.
2. NFC reading areas and the range of your smartphone vary from brand and model. Please refer to your smartphone manufacturer for detailed instructions.
3. Currently the NFC tag does not support cross-OS use. An activated tag can only be read by casting devices with the same operating system as the setting device.

Bluetooth Speaker Mode

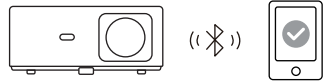
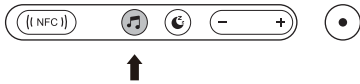

1. Click the Bluetooth Speaker Mode button on the projector.
2. Pair the mobile device with the projector to play music.

Quiet Mode

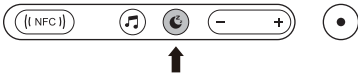

Click the Quiet Mode button on the projector to enter the Quiet Mode, and click again to exit.

Image Adjustment

When you turn on the projector, please wait patiently for 2-3 seconds, the projector will auto focus, auto keystone correct.

Focus Adjustment

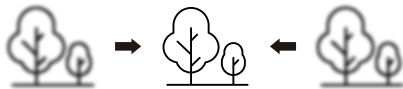
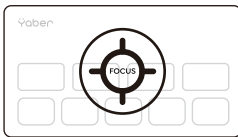

If the image is not clear. You can use the manual focus function, and press the focus buttons "F+" and "F-" on the remote control to adjust the focus of the lens, until the image is clear.

Note: If it is still blurry, please try adjusting to the best projection distance. The best projection distance is 2-3 meters.



Scan and download the PDF user manual



The terms HDMI, HDMI High-Definition Multimedia Interface, HDMI trade dress and the HDMI Logos are trademarks or registered trademarks of HDMI Licensing Administrator, Inc.

Where to Get More Help

✉ support@yabertech.com ✉ aftersales@yabertech.com 🌐 www.yaber.com

▶ @Yaber Entertainment Projector 📺 @Yaber Entertainment Projector

Yaber

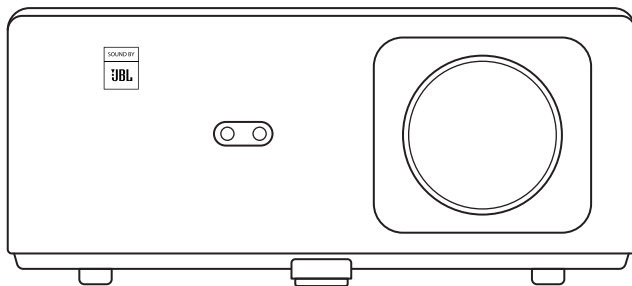

クイックスタートガイド

スマートプロジェクター-K2s **JP**

パッケージ内容

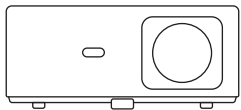

K2sプロジェクター

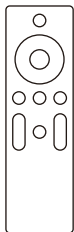

プロジェクターリモコン

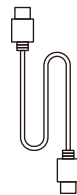

HDMIケーブル

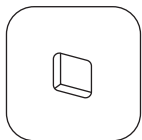

TVドングル



TVドングルリモコン

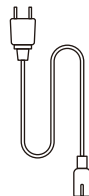

電源コード

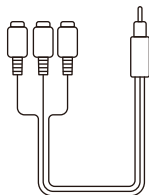

3-in-1 AVケーブル



クイックスタートガイド

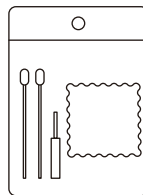

クリーニングキット



レンズカバー

製品概要

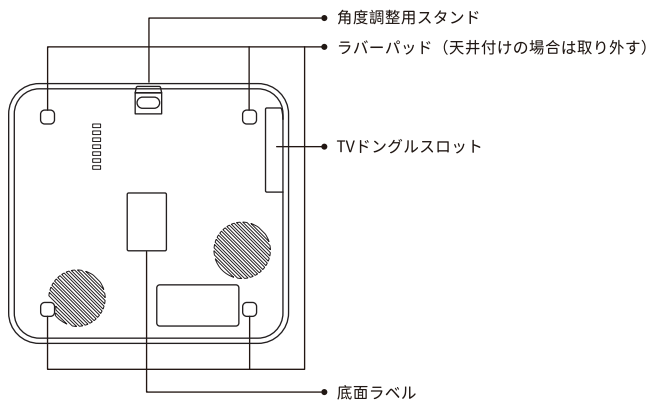
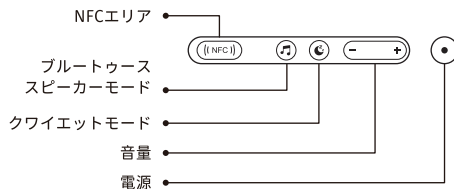
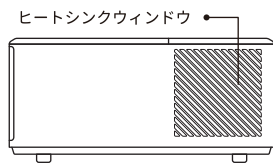
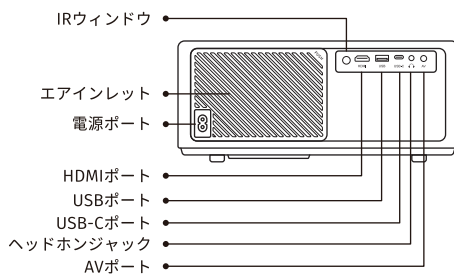
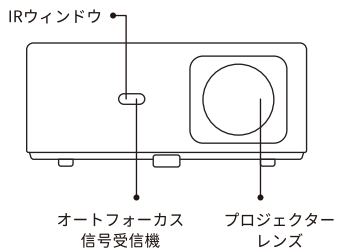

TVドングルの取り付け

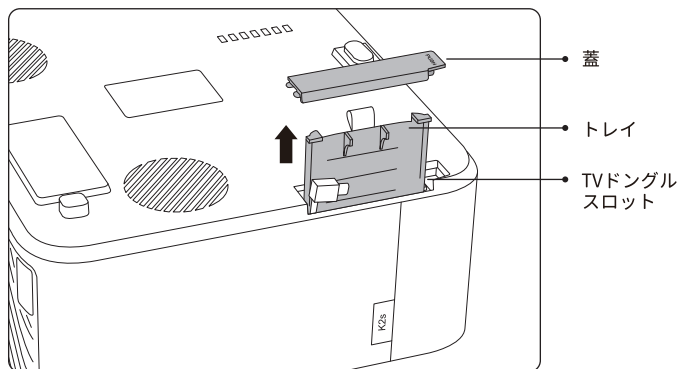

1. 一度押して蓋を開け、トレイを取り出します。

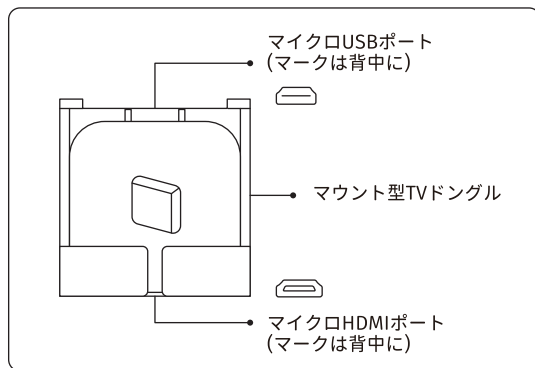

2. TVドングルを装着し、Micro HDMIポートの下側と
Micro USBポートの上側を確認してください。

TVドングルの取り付け

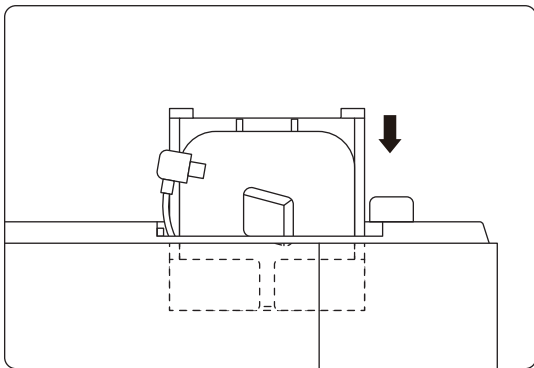

3. 装着したTVドングルをスロットに挿入してください。

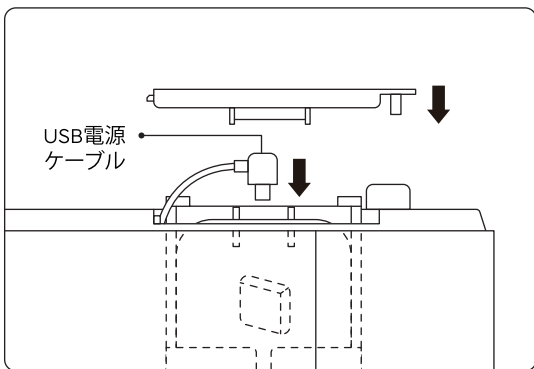

4. USB電源ケーブルをMicro USBポートに差し込み、蓋を押して閉じます。

Yaberプロジェクターの電源を入れる

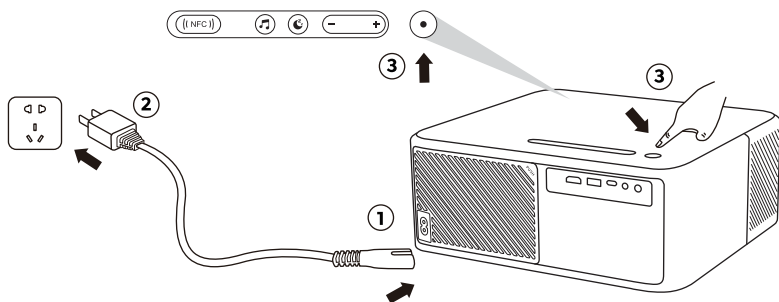

デバイスの接続

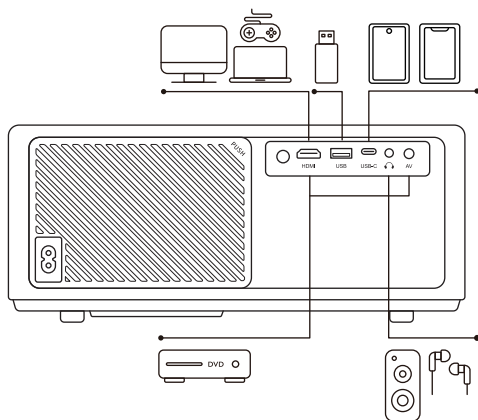

Yaber K2sプロジェクターには、HDMIポート/USBポート/USB-Cポート/AV_in/AUDIO outの5つのポートがあります。お使いのデバイスを接続するために、正しい接続ポートを選択してください。(PC、電話、DVDプレーヤー、Bluetoothスピーカー、USB)

NFCの設定

1. QRコードを読み取り、E-shareアプリをダウンロードし、インストールする。
(<http://h.eshare.app>)
2. 携帯電話とプロジェクターが同じネットワークに接続されていることを確認し、E-shareアプリでプロジェクターに接続します。

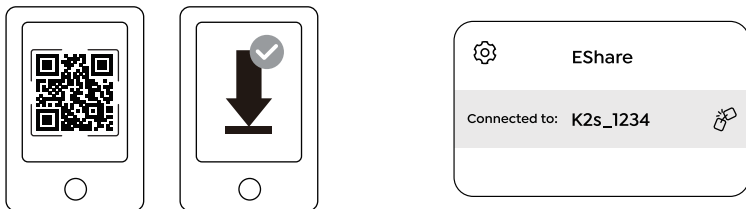

3. E-shareアプリの設定に移動し、「NFCタグを書く」を選択し、プロジェクターのNFCエリアを有効にするためにプロンプトに従います。
4. NFCエリアに携帯電話を密着させ、スクリーンキャストを行うことができるようになりました。（プロジェクターの電源が入っている状態で、携帯電話と同じWi-Fiネットワークに接続してください。）

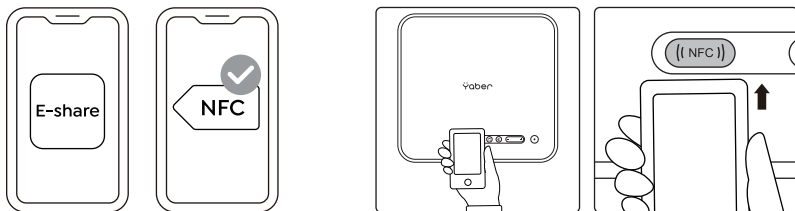

注※

1. NFCスクリーンキャストは、お使いのスマートフォンがプロジェクターのNFC検出エリアに触れる必要があり、天吊りには適さない場合がございます。
2. スマートフォンのNFC読み取りエリアと範囲は、ブランドやモデルによって異なります。詳細な手順については、お使いのスマートフォンのメーカーにお問い合わせください。
3. 現在、NFCタグはOSを超えた利用には対応しておりません。起動したタグは、設定機器と同じオペレーションシステムを持つキャストリング機器でのみ読み取ることができます。

Bluetoothモード

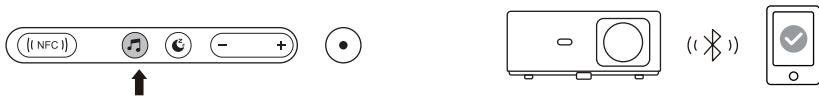

1. プロジェクターのBluetoothスピーカーモードボタンをクリックします。
2. モバイルデバイスとプロジェクターをペアリングし、音楽を再生します。

クワイエットモード

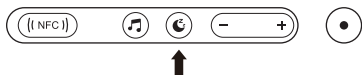

プロジェクターのQuiet ModeボタンをクリックしてQuiet Modeに入り、もう一度クリックしてQuiet Modeを終了します。

画像調整

プロジェクターをオンにすると、2-3 秒間待ってください、プロジェクターは自動焦点、自動台形補正をします。

フォーカスの調整

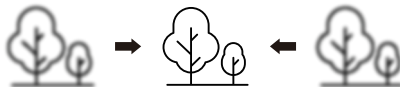
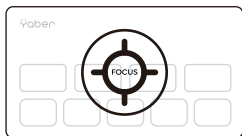

画像が鮮明でない場合、マニュアルフォーカス機能を使用することができます。リモコンのフォーカスボタン "F+"と "F-"を押して、画像が鮮明になるまで、レンズのフォーカスを調整することができます。

注：まだぼやけている場合は、最適な投影距離に調整してみてください。最適な投影距離は2～3メートルです。



PDF版取扱説明書をスキャンしてダウンロードする

その他のヘルプの入手先

✉ support@yabertech.com ✉ aftersales@yabertech.com 🌐 www.yaber.com

▶ [@Yaber Entertainment Projector](#) 📺 [@Yaber Entertainment Projector](#)

Yaber

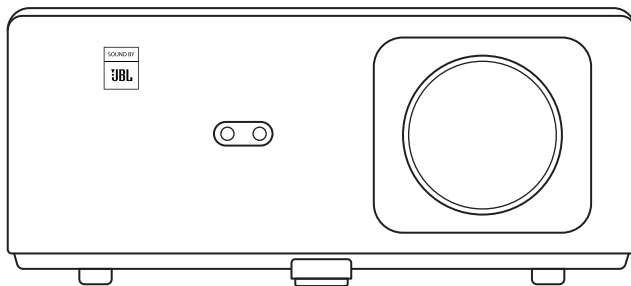

Guide de démarrage rapide

Projecteur intelligent K2s **FR**

Contenu de l'emballage

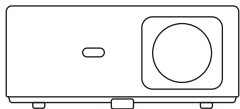

Projecteur K2s

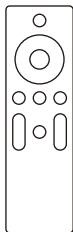

Télécommande
du projecteur

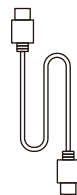

Câble HDMI

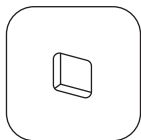

Dongle TV



Télécommande
du Dongle TV

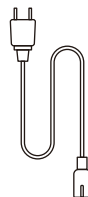

Cordon d'alimentation

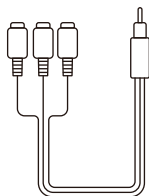

Câble AV 3-en-1



Guide de
démarrage rapide

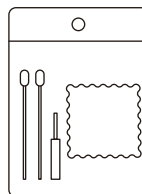

Trousse de nettoyage



Cache-objectif

Présentation du produit

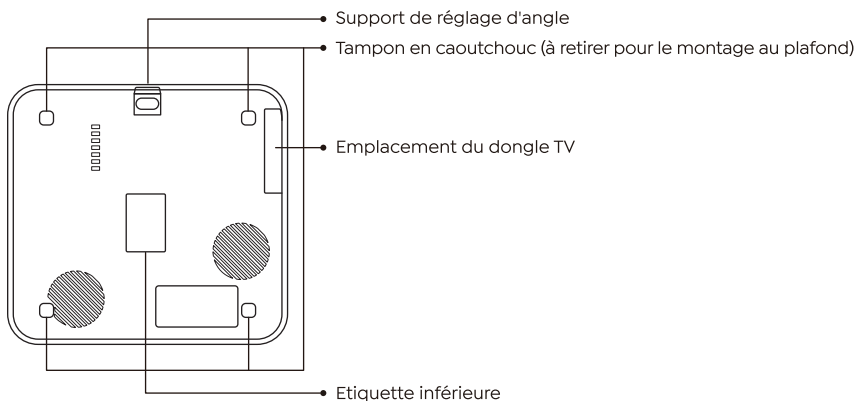
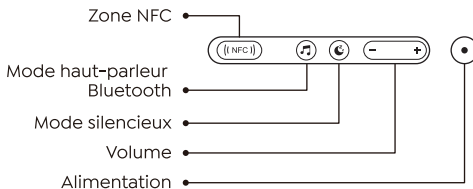
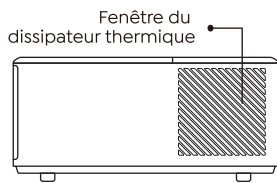
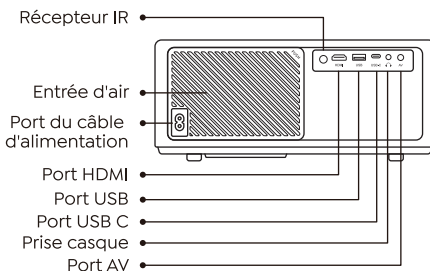
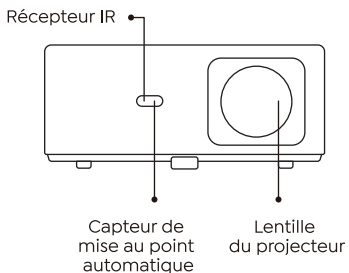

Installation du Dongle TV

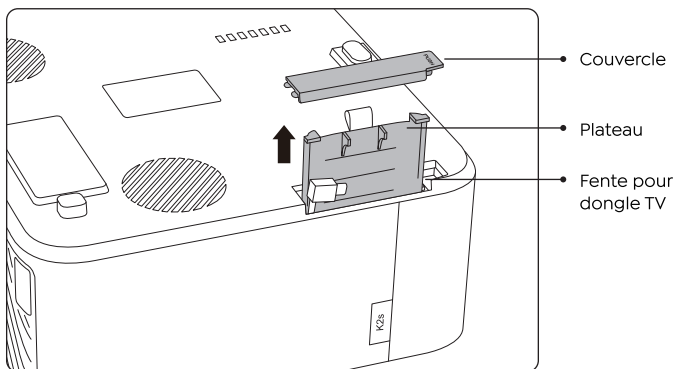

1. Appuyez une fois pour ouvrir le couvercle et sortez le plateau.

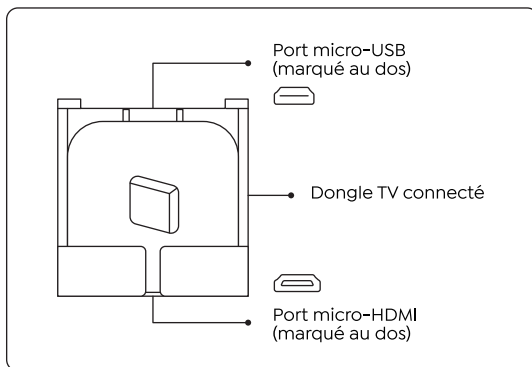

2. Montez le dongle TV et assurez-vous que le port Micro HDMI est inséré à l'envers et le port Micro USB également à l'envers.

Installation du Dongle TV

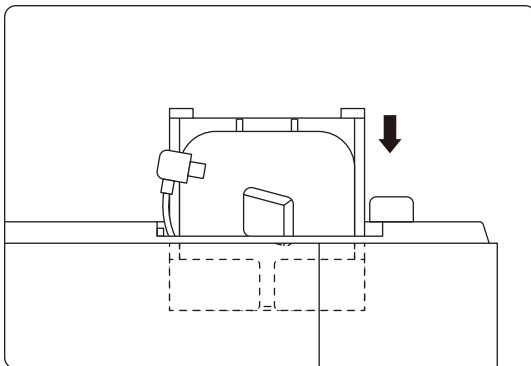

3. Insérez le dongle TV monté dans la fente.

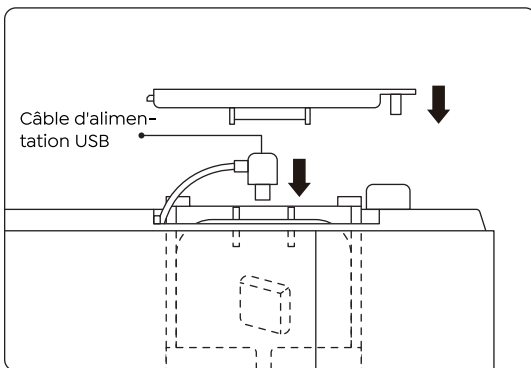

4. Branchez le câble d'alimentation USB dans le port micro USB et appuyez pour fermer le couvercle.

Turn on Yaber Projector

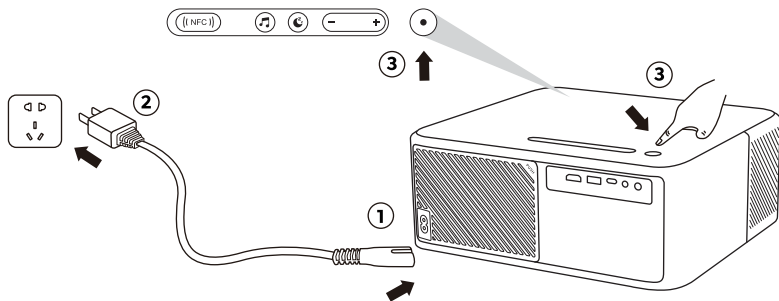

Connect Devices

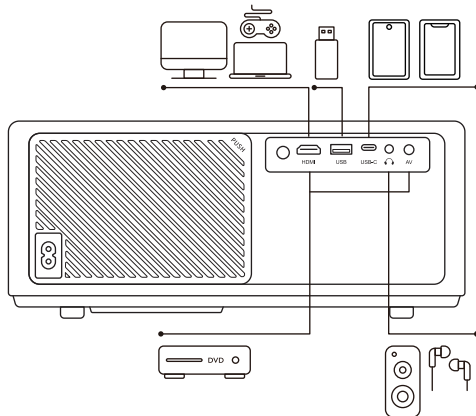

Le projecteur Yaber K2s dispose de 5 interfaces : port HDMI/port USB/port USB C/entrée AV/sortie AUDIO. Veuillez choisir le port adapté pour connecter votre appareil (PC, téléphone, lecteur DVD, haut-parleur Bluetooth, USB).

paramètres NFC

1. Téléchargez et installez l'application E-share en scannant le code QR ou en visitant <http://h.eshare.app>
2. Assurez-vous que votre téléphone et votre projecteur sont connectés au même réseau et connectez le projecteur sur l'application E-share.

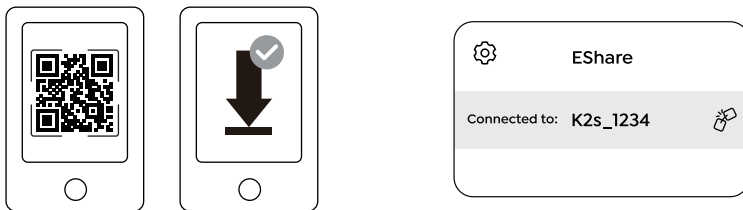

3. Allez dans Paramètres sur l'application E-share, sélectionnez "Écrire des balises NFC" et suivez les instructions pour activer la zone NFC sur le projecteur.
4. Maintenant, vous pouvez appuyer étroitement votre téléphone sur la zone NFC pour projeter pendant que le projecteur est allumé sur le même réseau Wi-Fi que votre téléphone.

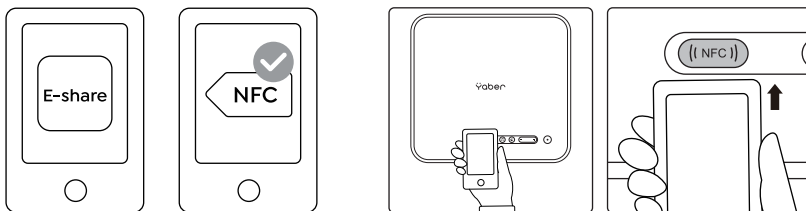

Note:

1. Le screencast NFC nécessite que votre téléphone touche la zone de détection NFC sur le projecteur, peut ne pas convenir à un montage au plafond.
2. Les zones de lecture NFC et la portée de votre téléphone intelligent varient selon les marques et les modèles. Veuillez vous référer au fabricant de votre smartphone pour des instructions détaillées.
3. Actuellement, le tag NFC ne supporte pas l'utilisation de plusieurs systèmes d'exploitation. Une balise activée ne peut être lue que par des appareils de projection ayant le même système d'exploitation que l'appareil de réglage.

Mode Bluetooth



1. Cliquez sur le bouton Mode haut-parleur Bluetooth sur le projecteur.
2. Associez l'appareil mobile au projecteur pour écouter de la musique.

Mode silencieux

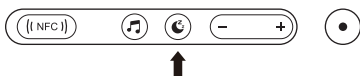

Cliquez sur le bouton Mode silencieux du projecteur pour accéder au mode silencieux, puis cliquez à nouveau pour quitter.

Réglage de l'image

Lorsque vous allumez le projecteur, veuillez attendre patiemment pendant 2 à 3 secondes, le projecteur effectuera la mise au point automatique ainsi que la correction trapézoïdale automatique.

Réglage de la mise au point

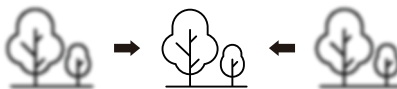
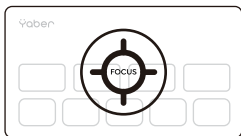

Si l'image n'est pas claire, vous pouvez utiliser la fonction de mise au point manuelle. Appuyez sur le bouton de mise au point "F+" et "F-" de la télécommande pour régler la mise au point de l'objectif, jusqu'à ce que l'image soit claire.

Remarque : si l'image est toujours floue, essayez de régler la meilleure distance de projection. La meilleure distance de projection est de 2 à 3 mètres.



Scannez et téléchargez le manuel d'utilisation PDF

Où obtenir plus d'aide

✉ support@yabertech.com ✉ aftersales@yabertech.com 🌐 www.yaber.com

▶ @Yaber Entertainment Projector 📺 @Yaber Entertainment Projector

Yaber

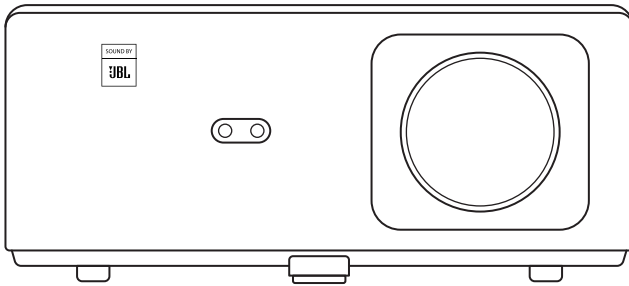

Kurze Startanleitung

Smart Beamer K2s **DE**

Lieferumfang

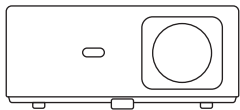

K2s Beamer

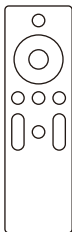

Projektor-Fernbedienung

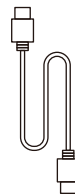

HDMI-Kabel

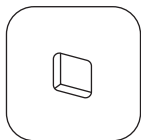

TV-Dongle

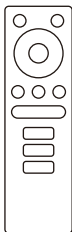

TV-Dongle-Fernbedienung

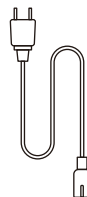

Netz Kabel

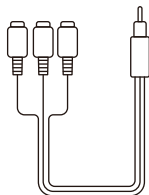

3-in-1-AV-Kabel



Schnellstartanleitung

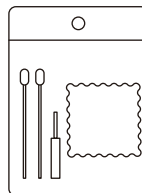

Reinigungskit



Objektivschutz

Produktübersicht

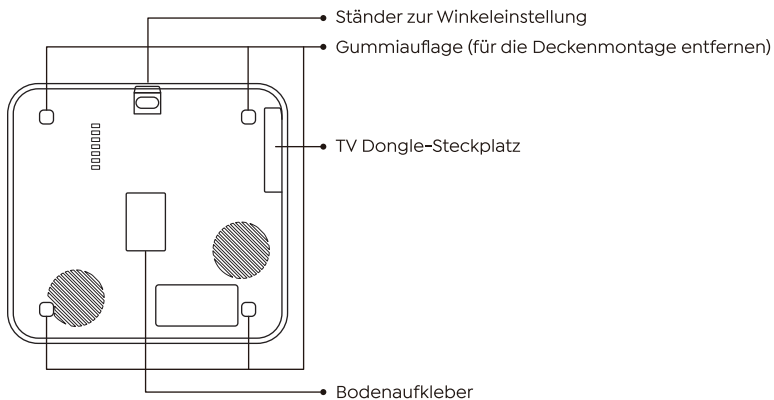
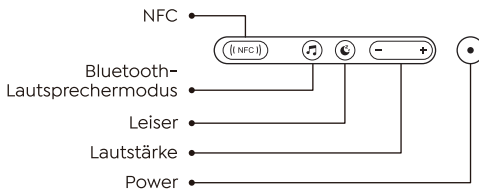
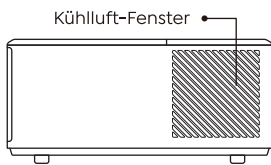
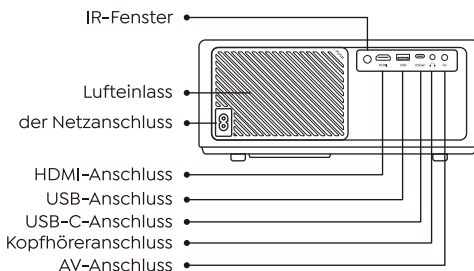
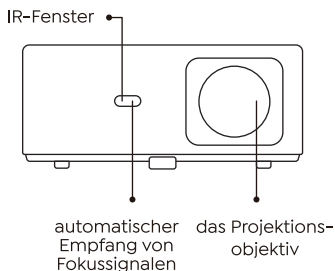

TV-Dongle installieren

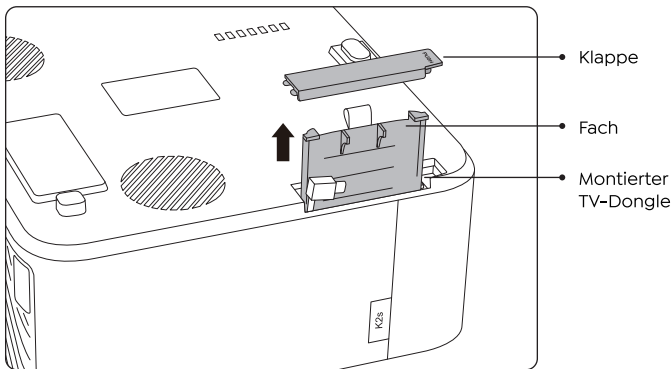

1. drücken Sie einmal, um den Deckel zu öffnen, und nehmen Sie das Fach heraus.

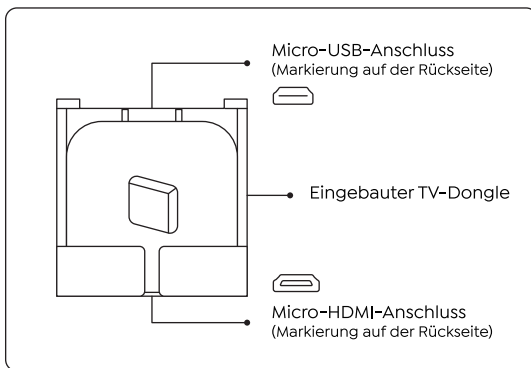

2. Montieren Sie den TV-Dongle und achten Sie darauf, dass der Micro-HDMI-Anschluss unten und der Micro-USB-Anschluss oben ist.

TV-Dongle installieren

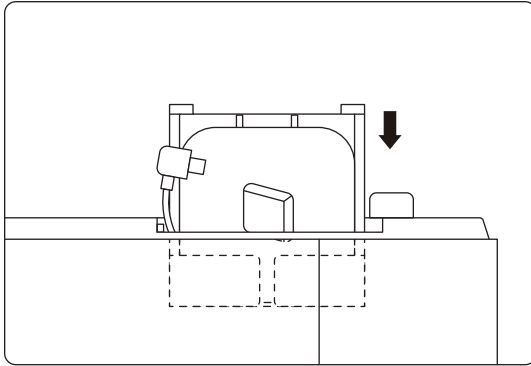

3. stecken Sie den eingebauten TV-Dongle in den Steckplatz.

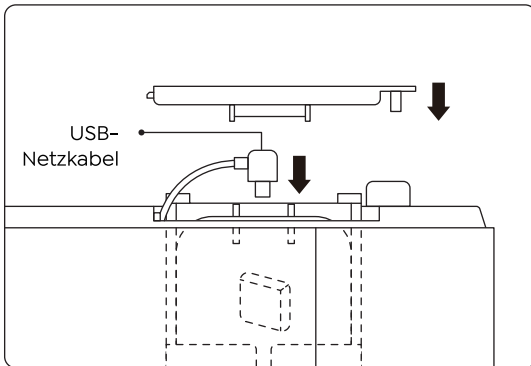

4. Stecken Sie das USB-Netzkabel in den Micro-USB-Anschluss, und drücken Sie auf den Deckel, um ihn zu schließen.

Yaber Beamer einschalten

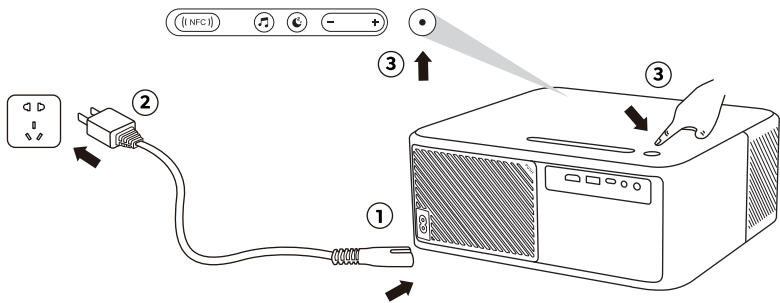

Gerät anschließen

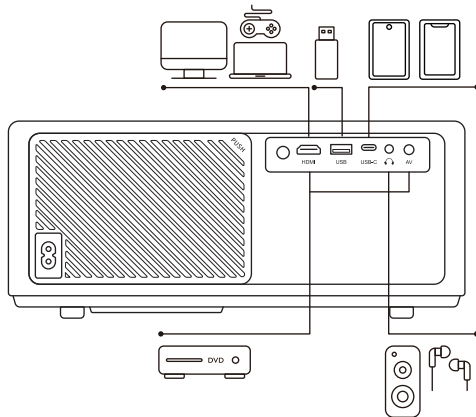

Der Yaber K2s Beamer hat 5 Anschlüsse, HDMI-Anschluss/USB-Anschluss/USB-C-Anschluss/AV_in/AUDIO out. Bitte wählen Sie den richtigen Anschluss, um Ihre Geräte anzuschließen. (PC, Telefon, DVD-Player, Bluetooth-Lautsprecher, USB)

NFC-Einstellungen

1. laden Sie die E-Share App herunter und installieren Sie sie, indem Sie den QR-Code scannen oder <http://h.eshare.app>
2. stellen Sie sicher, dass Ihr Telefon und der Projektor mit demselben Netzwerk verbunden sind, und verbinden Sie den Projektor mit der E-Share App.

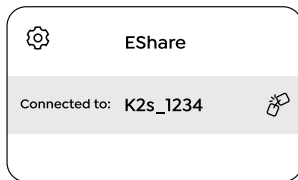
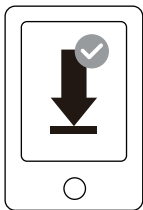

3. gehen Sie in der E-Share App zu Einstellungen, wählen Sie "NFC-Tags schreiben" und folgen Sie den Anweisungen, um den NFC-Bereich auf dem Projektor zu aktivieren.
4. jetzt können Sie Ihr Telefon genau auf den NFC-Bereich tippen, um Screenscasts zu machen während der Projektor eingeschaltet ist und sich im selben Wi-Fi-Netzwerk wie Ihr Telefon befindet.

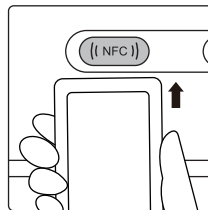
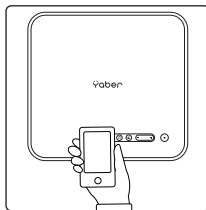
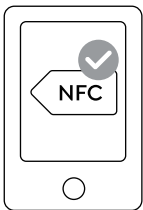
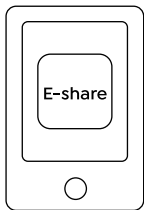

Hinweis:

1. NFC-Screencast erfordert, dass Ihr Telefon den NFC-Erkennungsbereich des Projektors berührt.
2. Die NFC-Lesebereiche und die Reichweite Ihres Smartphones variieren je nach Marke und Modell. Bitte wenden Sie sich an den Hersteller Ihres Smartphones für detaillierte Anweisungen.
3. Derzeit unterstützt das NFC-Tag keine betriebssystemübergreifende Anwendung. Ein aktivierter Tag kann nur von Casting-Geräten mit dem gleichen Betriebssystem wie das Einstellgerät gelesen werden.

Bluetooth-Modus



1 Klicken Sie auf die Schaltfläche Bluetooth-Lautsprechermodus am Projektor.

2. verbinden Sie das mobile Gerät mit dem Projektor, um Musik abzuspielen.

Leiser Modus

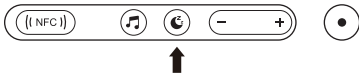

Klicken Sie auf die Taste "Leiser Modus" am Projektor, um den Leisemodus zu aktivieren, und klicken Sie nochmals, um ihn zu beenden.

Bildeinstellung

Wenn Sie den Projektor einschalten, warten Sie bitte geduldig 2-3 Sekunden, der Projektor stellt automatisch scharf und korrigiert die Trapezeinstellung automatisch.

Fokuseinstellung

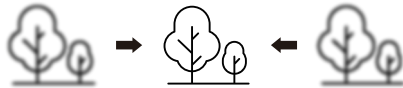
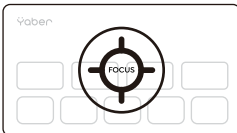

Wenn das Bild nicht klar ist, können Sie die manuelle Fokusfunktion verwenden. Drücken Sie die Fokustasten "F+" und "F-" auf der Fernbedienung, um den Fokus des Objektivs einzustellen, bis das Bild klar ist.

Hinweis: Wenn das Bild immer noch unscharf ist, versuchen Sie bitte, den besten Projektionsabstand einzustellen. Der beste Projektionsabstand beträgt 2-3 Meter.



Scannen und Herunterladen des PDF-Gebrauchsanweisung

Wo Sie weitere Hilfe erhalten

✉ support@yabertech.com ✉ aftersales@yabertech.com 🌐 www.yaber.com

▶ [@Yaber Entertainment Projector](#)  [@Yaber Entertainment Projector](#)

Yaber

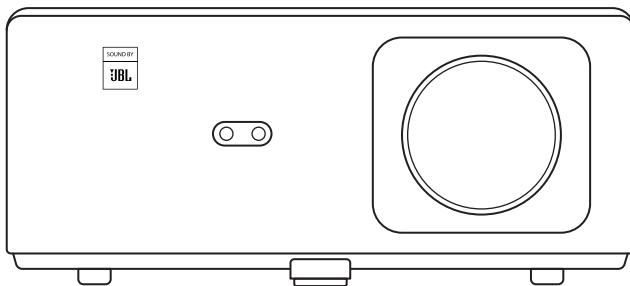

Guida Rapida

Intelligente Proiettore K2s **IT**

Contenuto della confezione

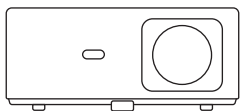

Proiettore K2s

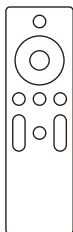

Telecomando del proiettore

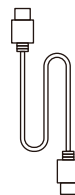

Cavo HDMI

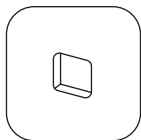

Dongle TV

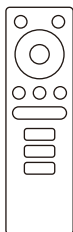

Telecomando a Dongle TV

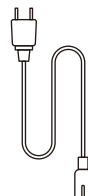

Cavo di alimentazione

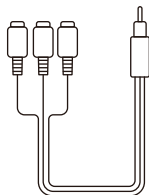

Cavo AV 3 in 1



Guida rapida

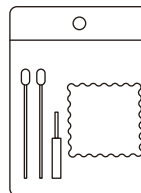

Kit di pulizia



Copertura dell'obiettivo

Panoramica del prodotto

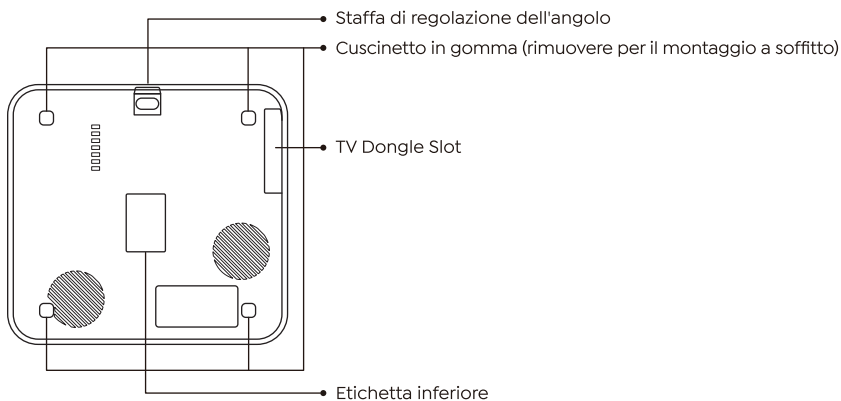
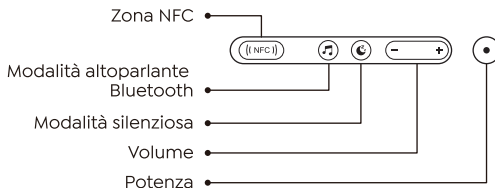
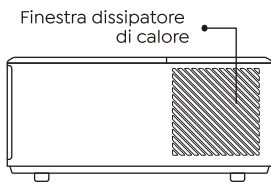
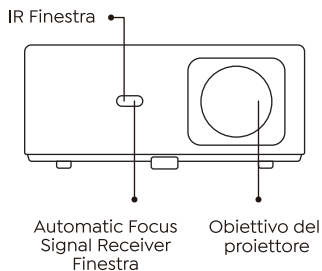

Install the TV Dongle

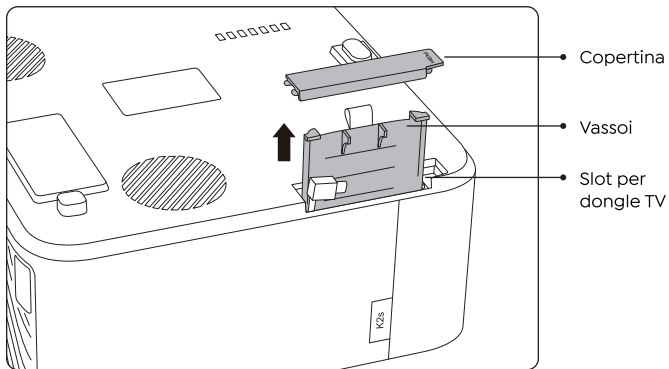

1. Spingere una volta per aprire il coperchio ed estrarre il vassoio.

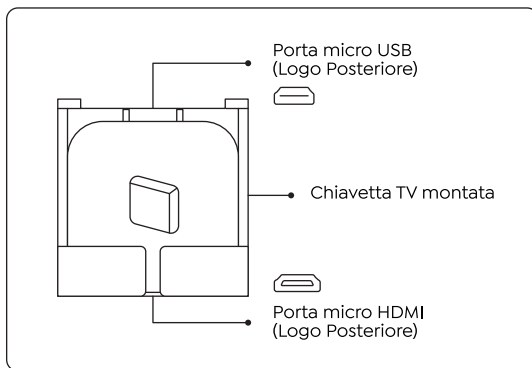

2. Montare il dongle TV e assicurarsi che la porta Micro HDMI sia rivolta verso il basso e la porta Micro USB sia rivolta verso l'alto.

Install the TV Dongle

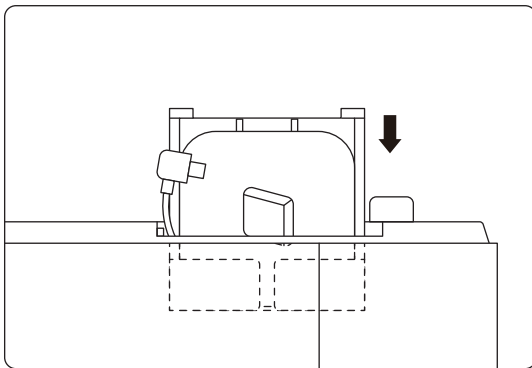

3. Inserire il dongle TV assemblato nello slot.

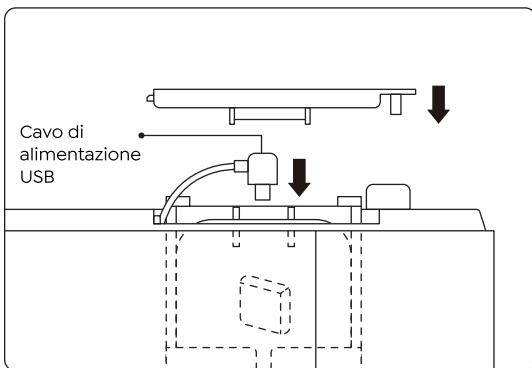

4. Inserire il cavo di alimentazione USB nella porta Micro USB e premere per chiudere il coperchio.

Attiva il proiettore Yaber

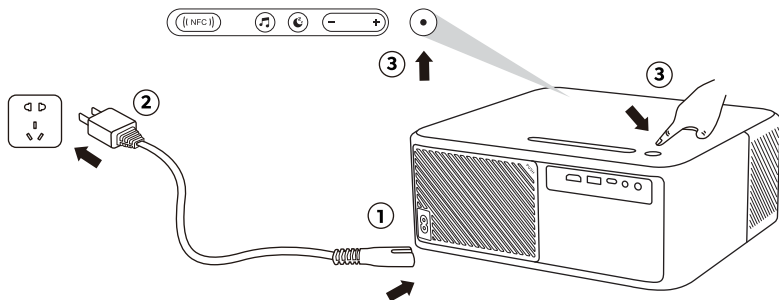

Collega dispositivi

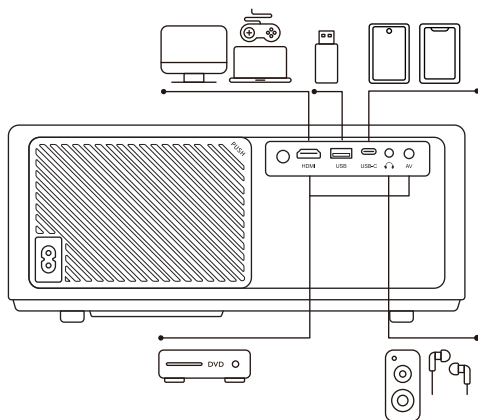

Il proiettore Yaber K2s ha 5 porte, porta HDMI/porta USB/porta USB-C/AV_in/uscita AUDIO. Selezionare la porta di connessione corretta per collegare i dispositivi. (PC, telefono, lettore DVD, altoparlante Bluetooth, USB)

Impostazioni NFC

1. Scarica e installa l'app E-share scansionando il codice QR o visita <http://h.eshare.app>
2. Assicurarsi che il telefono e il proiettore siano collegati alla stessa rete e collegare il proiettore nell'app E-share.

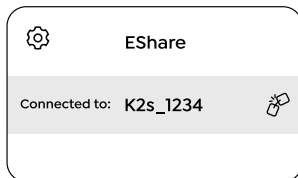
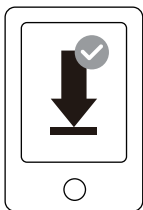

3. Andare su Impostazioni nell'app E-share, selezionare "Scrivi tag NFC" e seguire le istruzioni per attivare l'area NFC sul proiettore.
4. Ora puoi toccare il tuo telefono vicino all'area NFC per Screencastmentre il proiettore è acceso e sulla stessa rete Wi-Fi del telefono.

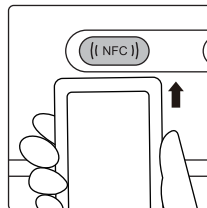
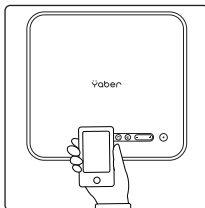
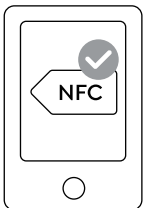
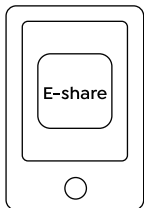

Nota:

1. Screencast NFC richiede che il telefono tocchi l'area di rilevamento NFC sul proiettore, potrebbe non essere adatto per il montaggio a soffitto.
2. aree di lettura NFC e la gamma dello smartphone variano da marche e modelli. Fare riferimento alla produzione del proprio smartphone per istruzioni dettagliate.
3. Attualmente il tag NFC non supporta l'uso cross OS. Un tag attivato può essere letto solo da dispositivi di fusione con lo stesso sistema operativo del dispositivo di impostazione.

Modalità Bluetooth

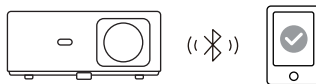

1. Fare clic sul pulsante Modalità altoparlante Bluetooth sul proiettore.
2. Associare il dispositivo mobile al proiettore per riprodurre la musica.

Modalità silenziosa

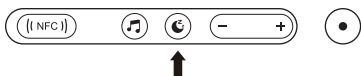

Fare clic sul pulsante Modalità silenziosa sul proiettore per entrare in modalità silenziosa e fare nuovamente clic per uscire.

Regolazione immagine

Quando accendi il proiettore, attendi pazientemente 2-3 secondi, il proiettore eseguirà la messa a fuoco automatica e la distorsione trapezoidale automatica verrà corretta.

Regolazione della messa a fuoco

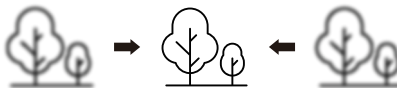
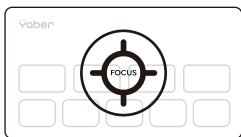

Se l'immagine non è chiara, è possibile utilizzare la funzione messa a fuoco manuale. Premere i tasti di messa a fuoco "F+" e "F-" sul telecomando per regolare la messa a fuoco dell'obiettivo, fino a quando l'immagine non è chiara.

Nota: Se è ancora sfocato, prova a regolare la distanza migliore del proiettore. La migliore distanza di proiezione è di 2-3 metri.



Scansiona e scarica il manuale utente PDF

Dove ottenere ulteriore aiuto

✉ support@yabertech.com ✉ aftersales@yabertech.com 🌐 www.yaber.com

▶ [@Yaber Entertainment Projector](#)  [@Yaber Entertainment Projector](#)

Yaber

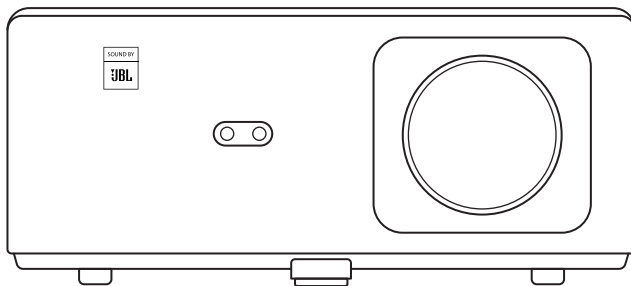

Guía de Inicio Rápido

Inteligente Proyector K2s **ES**

Contenidos del Paquete

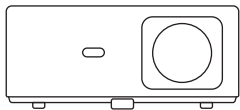

Proyector K2s

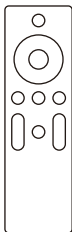

Control Remoto del Proyector

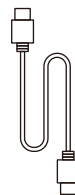

Cable HDMI

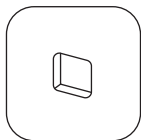

Dongle de Televisión

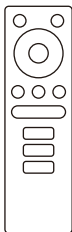

Control Remoto de Dongle de TV

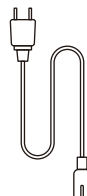

Cable de Alimentación

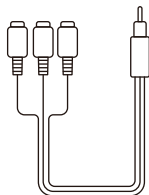

Cable AV 3 en 1



Guía de Inicio Rápido

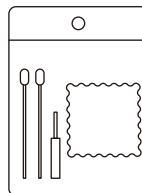

Kits de Limpieza



Cubierta de la Lente

Descripción General del Producto

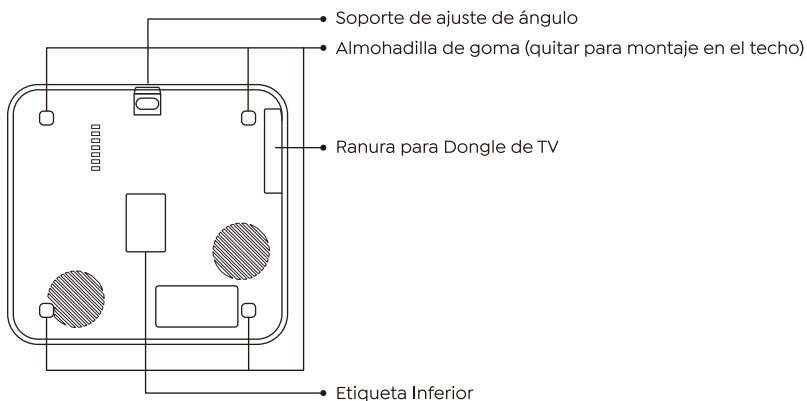
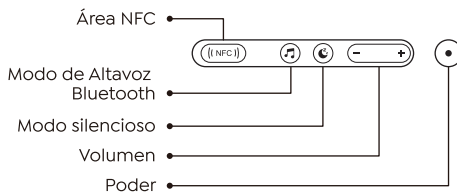
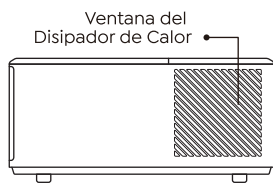
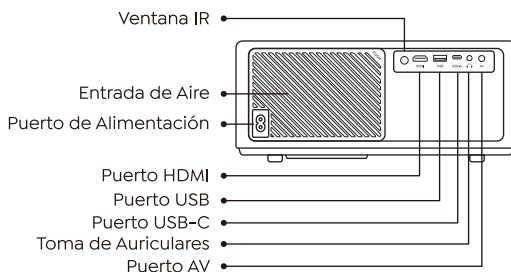
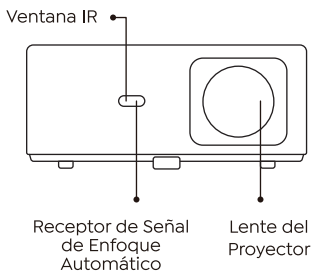

Instale el Dongle de TV

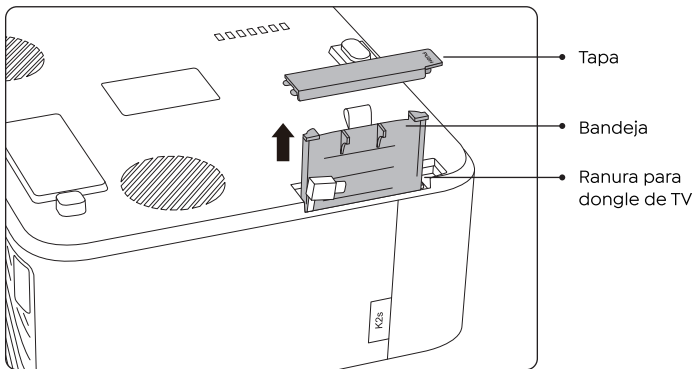

1. Empuje una vez para abrir la tapa y saque la bandeja.

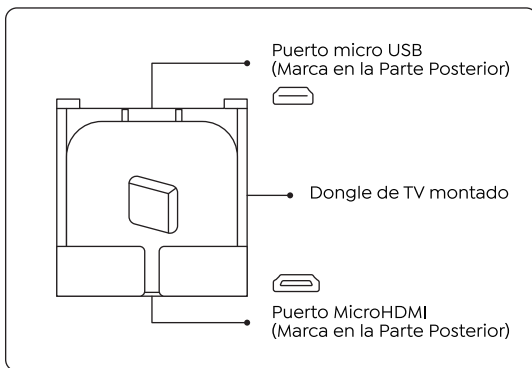

2. Monte el TV Dongle y asegúrese de que el puerto Micro HDMI esté hacia abajo y el puerto Micro USB hacia arriba.

Instale el Dongle de TV

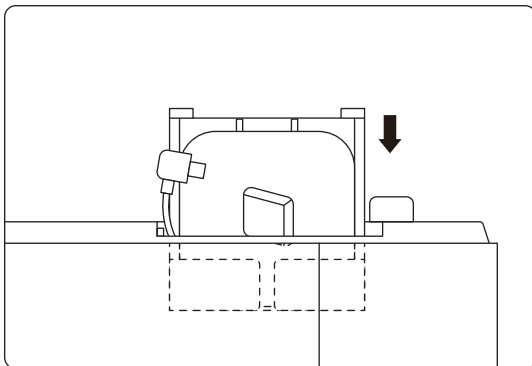

3. Inserte el TV Dongle montado en la ranura.

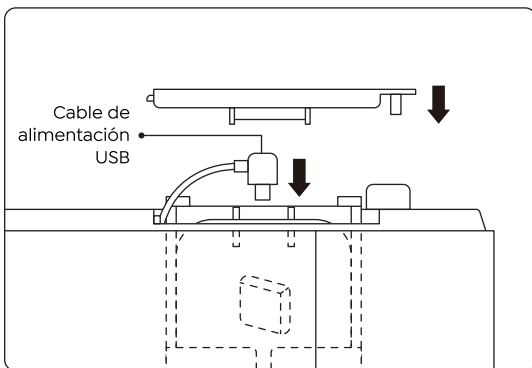

4. Enchufe el cable de alimentación USB en el puerto Micro USB y presione para cerrar la tapa.

Enciende el proyector Yaber

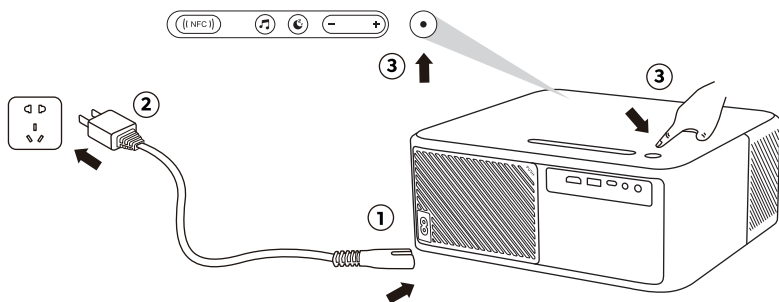

Conectar dispositivos

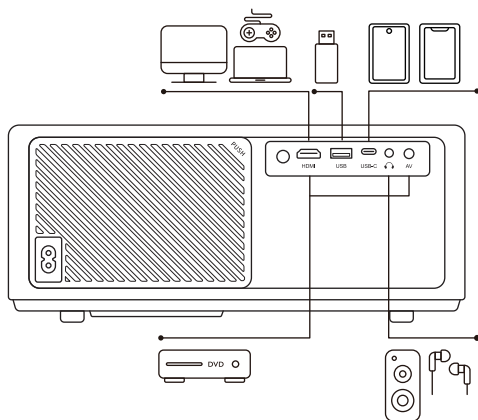

El proyector Yaber K2s tiene 5 puertos, puerto HDMI/puerto USB/puerto USB-C/entrada AV/salida de AUDIO. Seleccione el puerto de conexión correcto para conectar sus dispositivos. (PC, Teléfono, Reproductor de DVD, Altavoz Bluetooth, USB)

Configuración NFC

1. Descargue e instale la aplicación E-share escaneando el código QR o visite <http://h.eshare.app>

2. Asegúrese de que su teléfono y proyector estén conectados a la misma red y conecte el proyector en la aplicación E-share.

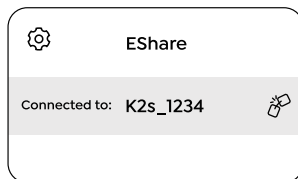
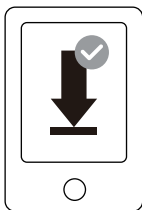

3. Vaya a Configuración en la aplicación E-share, seleccione "Escribir etiquetas NFC" y siga las indicaciones para activar el área NFC en el proyector.

4. Ahora puede tocar su teléfono de cerca en el área NFC para Screencast mientras el proyector está encendido y en la misma red Wi-Fi que su teléfono.

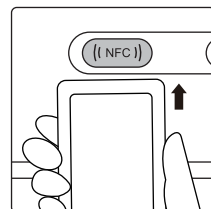
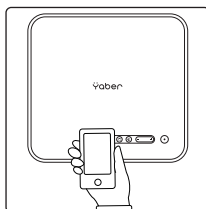
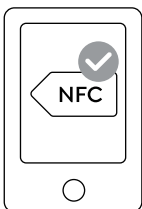
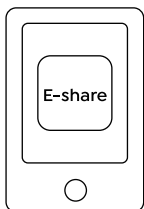

Nota:

1. NFC screencast requiere que su teléfono toque el área de detección NFC en el proyector, puede que no sea adecuado para el montaje en el techo.

2. Las áreas de lectura NFC y el alcance de su teléfono inteligente varían según las marcas y los modelos. Consulte al fabricante de su teléfono inteligente para obtener instrucciones detalladas.

3. Actualmente, la etiqueta NFC no admite el uso entre sistemas operativos. Una etiqueta activada solo puede ser leída por dispositivos de fundición con el mismo sistema operativo que el dispositivo de configuración.

Modo Bluetooth



1. Haga clic en el botón Modo de altavoz Bluetooth en el proyector.
2. Empareje el dispositivo móvil con el proyector para reproducir música.

Modo Silencioso

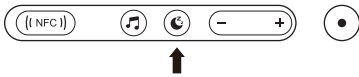

Haga clic en el botón de Modo silencioso para ingresar al modo silencioso y haga clic nuevamente para salir.

Ajuste de Imagen

Cuando encienda el proyector, espere pacientemente de 2 a 3 segundos, el proyector se enfocará automáticamente y la distorsión trapezoidal automática comenzará a corregirse.

Ajuste de Enfoque

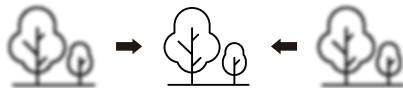
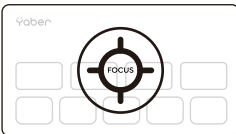

Si la imagen no es nítida, puede utilizar la función de enfoque manual. Pulse las teclas de enfoque "F+" y "F-" del mando a distancia para ajustar el enfoque del objetivo hasta que la imagen sea clara.

Nota: Si sigue siendo borrosa, intente ajustarla a la distancia de proyección óptima. La distancia óptima de proyección es de 2-3 metros.



Escanee y descargue el manual de usuario en PDF

Dónde Obtener Más Ayuda

✉ support@yabertech.com ✉ aftersales@yabertech.com 🌐 www.yaber.com

▶ @Yaber Entertainment Projector 📺 @Yaber Entertainment Projector



Leader of Entertainment Projectors