



FIELDMANN[®]
Home & Garden Performance

20V Li-ION
FASTPOWER



FZN 70405-0

English	5-18
Čeština.....	19-32
Slovenčina	33-46
Magyarul	46-60
Polski	61-74

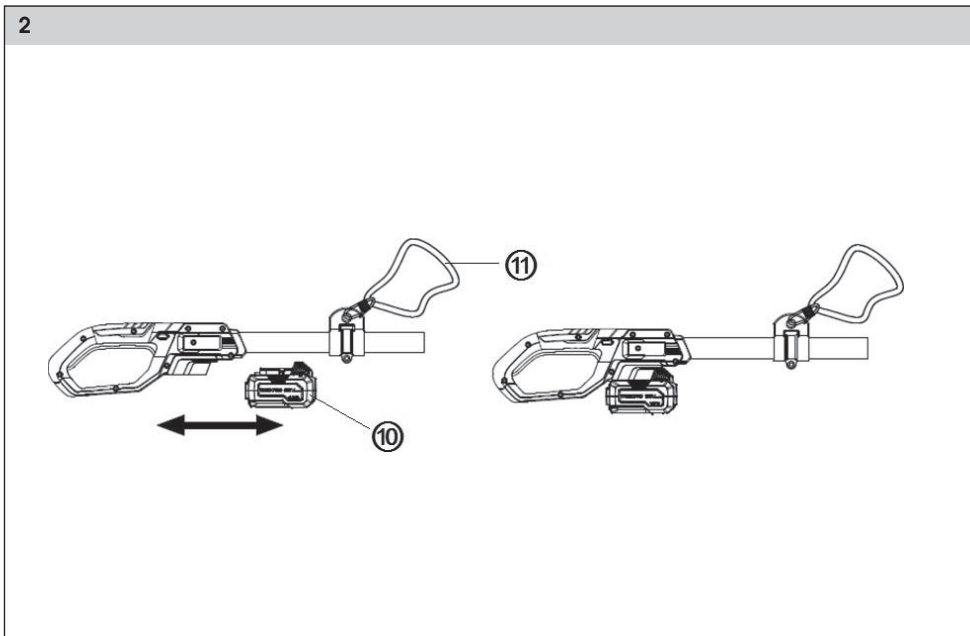
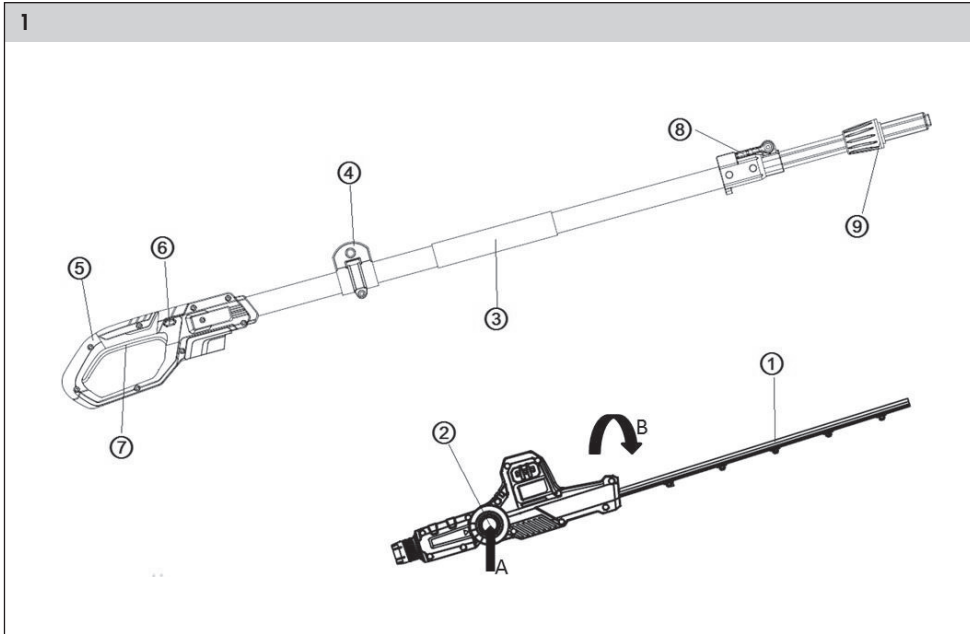

3

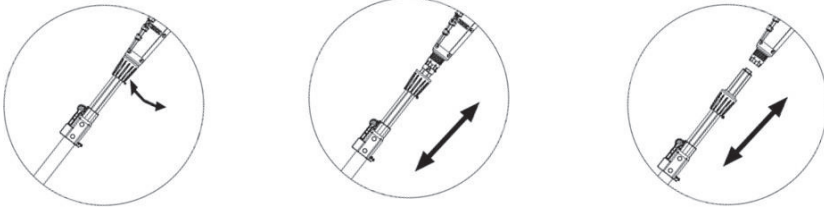

4

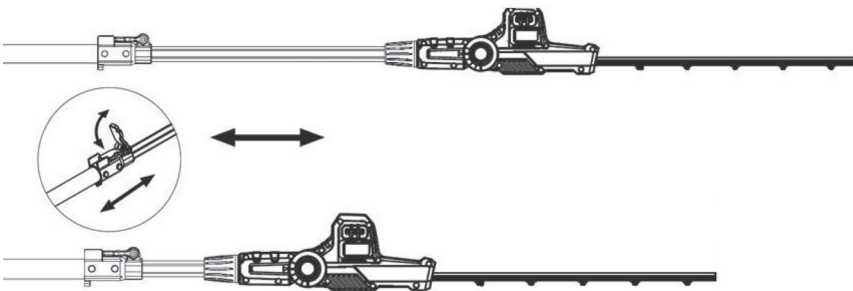

Pole Hedge Trimmer

USER'S MANUAL

TABLE OF CONTENTS



1. IMPORTANT SAFETY INSTRUCTIONS.....	6
2. SYMBOLS.....	7
3. SAFETY INSTRUCTIONS.....	9
4. MACHINE DESCRIPTION AND PACKAGE CONTENT.....	13
5. OPERATION.....	14
6. MAINTENANCE.....	15
7. STORAGE.....	15
8. TECHNICAL DATA.....	16
9. DISPOSAL.....	17
10. DECLARATION OF CONFORMITY.....	18

1. IMPORTANT SAFETY INSTRUCTIONS

WARNING!

Carefully read the instruction manual before use.

IMPORTANT SAFETY WARNINGS

-  Unpack the product carefully and be sure not to throw away any part of the package before having found all components of the product.
-  Keep the product in a dry place out of reach of children.
-  Read all cautions and instructions. The failure to adhere to warning cautions and instructions may result in an accident, fire and/or a serious injury.

PACKAGING

The product is placed in a package preventing damage during transport. This package is a raw material therefore it can be handed-over for recycling.

INSTRUCTIONS FOR USE

Before beginning to work with the machine, read the following safety rules and instructions for use. Familiarize with operating elements and the proper use of the device. Keep the manual in a safe place for future reference. We recommend keeping the original package including the inner packaging materials, cash voucher and guarantee card for a period of warranty at minimum. For a case of transportation, pack the machine into the original box from the manufacturer, thus ensuring a maximum protection of the product during a possible transport (e.g. moving or sending into a service station).

 **Note:** If you hand the machine over to next persons, hand it over together with the manual. Adherence to the attached instructions for use is a precondition for the proper use of the machine. The operation manual includes also instructions for operation, maintenance and repairs.

The manufacturer does not take any responsibility for accidents or damages resulting from the failure to adhere to this manual.

2. SYMBOLS



WARNING!



Read the Instruction Manual attentively prior to use.



Protect the tool from the damp and never expose it to rain!

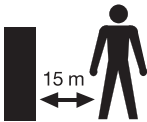

Keep other persons in distance!
WARNING! When operating the device, take care that no other persons are nearby (safe distance: 15m). This is particularly valid for children and animals.



Use ear, eye and head protection.



Wear work gloves.



Beware of falling branches.



Wear work shoes.

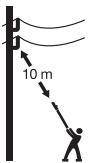

WARNING! When operating the device, take care that any power line is not close (safe distance: 10m).

3. SAFETY INSTRUCTIONS

Attention!

ATTENTION! For safety reasons, the hedge trimmer may not be operated by persons under 16 years of age and by persons not familiarized with information contained in this manual. Persons with reduced mental or physical abilities may operate the hedge trimmer only if they are under supervision of a responsible person or have been trained by a qualified responsible person.

Attention!

In case of improper use, this power tool may be dangerous. Follow warning and safety instructions specified in the instruction manual; only this way you will ensure adequate safety and efficiency when working with this tool. The compliance with the warning and safety instructions specified in this instruction manual and on the tool is the responsibility of the tool operator. Never use the tool unless the protective guards mounted by the tool manufacturer are in the correct position.

BASIC SAFETY INSTRUCTIONS WHEN WORKING WITH POWER TOOLS

Attention!



WARNING! Familiarize yourself with all the warning and safety instructions and with the tool operating instructions. Failure to adhere to warning or safety instructions may result in electric shock, fire and/or serious injury

Attention!



Keep all the warning and safety instructions in a practical place for future reference.

The term "power tool" in all warning instructions specified hereafter means both mains-operated (corded) and battery-operated (cordless) power tool.

WORK AREA SAFETY

-  Keep work area clean and well lit. Cluttered or dark areas at the workplace invite accidents. Do not operate power tools in explosive atmospheres, such as in the presence of flammable liquids, gases or dust. Power tools create sparks which may ignite the dust or fumes.
-  Keep children and bystanders away while operating a power tool. Distractions can cause you to lose control over the activity performed.

ELECTRICAL SAFETY

-  Power tool plugs must match the mains outlet. Never modify the plug in any way. Do not use any adapter plugs with earthed (grounded) power tools. Unmodified plugs and matching outlets will reduce the risk of electric shock.
-  Avoid body contact with earthed or grounded surfaces, such as pipes, radiators, ranges and refrigerators. There is an increased risk of electric shock if your body is earthed or grounded. Do not expose power tools to rain or wet conditions. Water entering a power tool will increase the risk of electric shock.
-  Do not abuse the cord. Never use the cord for carrying, pulling or unplugging the power tool. Keep cord away from heat, oil, sharp edges or moving parts. Damaged or entangled cords increase the risk of electric shock.

- ✿ When operating a power tool outdoors, use an extension cord suitable for outdoor use. Use of a cord suitable for outdoor use reduces the risk of electric shock.
- ✿ If operating a power tool in a damp location is unavoidable, use a residual current device (RCD) protected supply. Use of residual current device (RCD) reduces the risk of electric shock.

PERSONAL SAFETY

- ✿ Stay alert, watch what you are doing and use common sense when operating a power tool. Do not use a power tool while you are tired or under the influence of drugs, alcohol or medication. A moment of inattention while operating power tools may result in serious personal injury.
- ✿ Use personal means of protection. Always wear eye protection. Safety equipment such as dust mask, non-skid safety shoes, hard hat, or hearing protection used in conformity with the working conditions will reduce personal injuries.
- ✿ Avoid accidental starting. Ensure the switch is in the off-position before connecting the battery, storing or carrying the power tool. Carrying power tools with your finger on the switch or plugging in power tools that have the switch on invites accidents.
- ✿ Remove any adjusting tools or wrenches before turning the power tool on. An adjusting tool or wrench left attached to a rotating part of the power tool may result in personal injury.
- ✿ Do not overreach. Keep proper footing and balance at all times. This enables better control of the power tool in unexpected situations.
- ✿ Dress properly. Do not wear loose clothing or jewellery. Keep your hair, clothing and gloves away from moving parts. Loose clothes, jewellery or long hair can be caught in moving parts. If devices are provided for the connection of dust extraction and collection facilities, ensure these are connected and properly used. Use of these devices can reduce dust-related hazards.

POWER TOOL USE AND MAINTENANCE

- ✿ Do not force the power tool. Use the correct power tool for your application. The correct power tool will do the job better and safer at the rate for which it was designed.
- ✿ Do not use the power tool if the switch does not turn it on and off. Any power tool that cannot be controlled with the switch is dangerous and must be repaired.
- ✿ Unplug the power cord from the mains outlet and/or remove the battery from the power tool before making any adjustments, changing accessories, or storing power tools. Such preventative safety measures reduce the risk of starting the power tool accidentally.
- ✿ Store idle power tools out of the reach of children and do not allow persons unfamiliar with the power tool or these instructions to operate the power tool. Power tools are dangerous in the hands of untrained users.
- ✿ Maintain power tools. Check for misalignment or binding of moving parts, pay particular attention to cracks, breakage of parts and any other condition that may affect the power tool's operation. If damaged, have the power tool repaired before use. Many accidents are caused by poorly maintained power tools.
- ✿ Keep cutting tools sharp and clean. Properly maintained cutting tools with sharp cutting edges are less likely to bind and are easier to control.
- ✿ Use the power tool, accessories and tool bits etc., in accordance with these instructions and in the manner intended for the particular type of power tool, considering the given working conditions and the work to be performed. Use of the power tool for operations other than those for which the power tool is intended could result in hazardous situations.

SERVICE

- ✿ Have your power tool serviced by a qualified repair person using only original replacement parts. This will ensure that the safety of the power tool is maintained.

SAFETY INSTRUCTIONS WHEN WORKING WITH HEDGE TRIMMER

- ✿ Keep all parts of the body away from the cutter blade. Do not remove cut material or hold material to be cut when blades are moving. Make sure the main switch is off when clearing the material jammed in the hedge trimmer. A moment of inattention while operating the hedge trimmer may result in serious personal injury.
- ✿ Carry the hedge trimmer by the handle with the cutter blade stopped. Always fit the blade scabbard while transporting or storing the hedge trimmer. Proper handling of the telescopic hedge trimmer will reduce possible personal injury from the cutter blades.
- ✿ Hold the power tool by insulated gripping surfaces only to avoid contact of the cutter blades of the hedge trimmer with hidden electric wires or its own power cord. Cutter blade contacting "live" wire may expose metal parts of the power tool "live" and could give the operator an electric shock.
- ✿ Keep the power cord away from the cutting area. During operation the cable may be hidden in shrubs and may be accidentally cut by the blade.

ADDITIONAL SAFETY INSTRUCTIONS

- ✿ Work area safety Use power tools solely in the manner and for the purpose described in these operating instructions. The operator or user of the tool is fully responsible for possible accidents or potential danger to other persons or their property.

ELECTRICAL SAFETY

- ✿ To increase safety, the British Standards Institute recommends using residual current device (RCD) protected supply with tripping current of 30mA or less when operating power tools. Before each use of the power tool check the function of the residual current device. Before use check the integrity of the power cord. If the cord shows signs of wear and tear or damage, replace it.
- ✿ Do not use the tool, if the cables are damaged or worn out.
- ✿ If the cord is cut or its insulation is damaged, immediately de-energize the tool. Do not touch the cable until the device is de-energized.
- ✿ Keep the cable straight and untangled. Entangled cables may overheat and reduce the performance of your tool.
- ✿ Before unplugging the power cord or extension cord, always first switch off the tool using the mains switch.
- ✿ Switch off the tool, unplug the cable and before winding and storing the cable check whether it is not excessively worn out or damaged. Do not repair damaged cable, always replace it by a new one.
- ✿ Wind the cable carefully to prevent kinking.
- ✿ To power the tool, use exclusively alternating voltage power network with parameters matching the information on the tool's type label.
- ✿ Under no circumstances connect any part of the tool to an earth wire.

CABLES

- ✿ Use only extension cables approved according to HD 516 standard. Seek a technician - electrician.

PERSONAL SAFETY

- ✿ Always wear appropriate work clothing, protective gloves and solid shoes.
- ✿ Before cutting, inspect the shrubs thoroughly and remove any foreign objects and wires. When adjusting the tool (rotating the cutting unit, tilting the cutter, etc.), fit the blade scabbard first. During these operations the hedge trimmer may not lean against the cutting blade.
- ✿ Each time before you start using the tool and after any impact which occurred during cutting check for possible hedge trimmer wear and tear or damage and have it repaired, if necessary. Before commencing work with the telescopic hedge trimmer, always make sure that the hand protection shield is attached in the correct position.
- ✿ Never use tool which is incomplete or tool which was modified in an unauthorised manner.

POWER TOOL USE AND MAINTENANCE

- ✿ Familiarize yourself with instructions for quick emergency power off of the tool.
- ✿ Never carry the tool while holding the blade scabbard.
- ✿ Never use the hedge trimmer if its protective elements (hand protection shield, both-hand safety switch, blade scabbard, cutting blade emergency switch) are damaged.
- ✿ Never use ladder while operating the hedge trimmer. Unplug the power cord:
 - before leaving the tool unattended for any period of time,
 - before cleaning any material jammed in the cutting blade,
 - before any inspection, cleaning or maintenance of the tool,
 - after contact of the cutting tool with a foreign object.
- ✿ Do not operate the tool unless you are certain of its absolutely safe operating condition,
 - if the tool starts to unusually vibrate. In such case, check the tool immediately. Excessive vibration may result in injury.
 - before handing the tool over to another person.

MAINTENANCE AND STORAGE

Attention!

DANGER OF INJURY! Do not touch the cutting blades.

Attention!

After completion or interruption of work, lift the blade scabbard.

- ✿ Keep all nuts and bolts properly tightened to ensure safe operation of the tool.

4. MACHINE DESCRIPTION AND PACKAGE CONTENT

Figure 1: Hedge trimmer

1. Cutting tool
2. Safety button for setting the cutting angle
3. Front handle
4. Eyelet for attaching the shoulder strap
5. Rear handle
6. Safety button for on / off switch
7. On / off switch
8. Fastening lever for telescopic extension
9. Rotary eyes for attaching the telescopic extension to the cutting head

Figure 2: For commissioning

10. Insert the battery (not included in the package) in the guide rail provided
11. Shoulder strap

Figure 3: Uninstalling the motor with cutting head from the telescopic rod for space-saving storage or for transportation

Figure 4: Operating the telescope extension

5. OPERATION

SWITCH DEVICE ON / OFF

Insert the battery into the designated rail. Then press the safety button (Figure 1, point 6) sideways, only then can you operate the on / off switch (Figure 1, point 7). The device now starts. When you release the on / off switch, the device stops working. Attention: The cutting tool can still run a little.

WORK INSTRUCTIONS

- ✿ Hold the device with both hands on the handles provided.
- ✿ The hedge trimmer can move forward with its double-sided cutting knife and backwards or with a pendulum movement from one side to the other side.

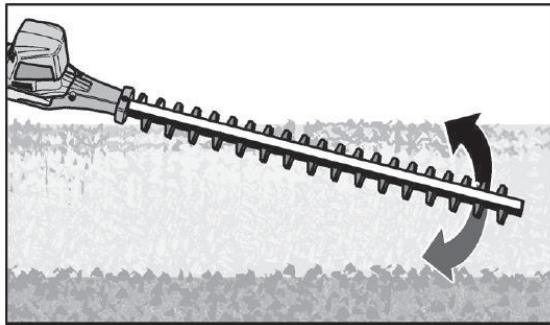

- ✿ First cut the sides of the hedge and then the top edge.
- ✿ Cut the hedge from bottom to top.
- ✿ Hold the hedge trimmer at an angle of 5–10° to the hedge to create a straight cut.
- ✿ Cut the hedge trapezoidal. This prevents discoloration of the lower hedge area due to lack of light.

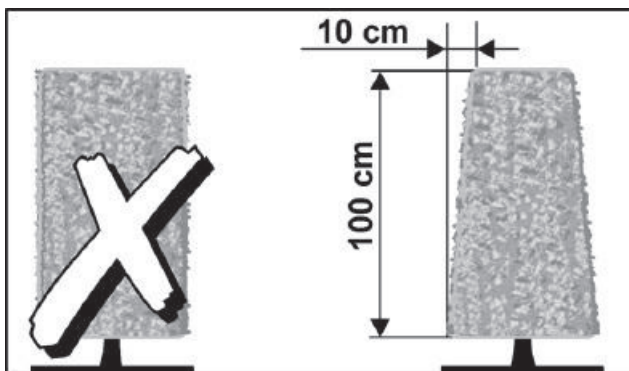

- ✿ Cut the top edges of the hedge slightly round.

- ✿ Cut in multiple passes when heavy pruning is required.
- ✿ If necessary, tension a guide if you want to cut the hedge evenly.
- ✿ Trim the young hedge plants to the desired shape. The main shoot should not be damaged until the hedge has reached the desired height. All other shoots can be cut in half.
- ✿ Dispose of the clippings properly and environmentally.
- ✿ Cutting times: Leaf hedges:
 - June + October
 - Conifers: April and August
 - Fast growing hedges (e.g. conifers): from May about every 6 weeks
- ✿ **Warning:** watch out for breeding birds in the hedge. Only cut after the brood or leave out this area of the hedge.

6. MAINTENANCE

CLEANING THE HEDGE TRIMMER

Attention!

Danger of injury / electric shock!

Before any tool maintenance, always unplug the tool from power supply and fit the blade scabbard. Do not clean the hedge trimmer under running water (particularly not pressure water).

- ✿ Wipe the hedge trimmer using wet cloth.
- ✿ Lubricate the hedge trimmer blade using a low-viscosity lubricant. Make sure the lubricant does not come in contact with plastic parts.

7. STORAGE

Attention!

Store the hedge trimmer out of the reach of children .

- ✿ Unplug the power cord from the hedge trimmer.
- ✿ Clean the hedge trimmer according to the instructions in Chapter 7 Maintenance and fit the blade scabbard.
- ✿ Store the hedge trimmer in a dry place without the frost risk.

8. TECHNICAL DATA

Model	FZN 70405-0
Rated voltage	20 V
Bar Length	420 mm
Cutting Dia.	16 mm
Blade speed	2 800/min
Max operation time	45 min (2Ah), 90 min (4Ah)

ACCESSORIES

Item number	Accessory
FDUZ 79020	Battery pack 2 Ah
FDUZ 79040	Battery pack 4 Ah
FDUZ 79100	Fast charger
FDUZ 79110	Fast dual charger

9. DISPOSAL



The machine, rechargeable batteries, accessories and packaging should be sorted for environmental friendly recycling.

Do not dispose of power tools and batteries/rechargeable batteries into household waste!

Only for EC countries:



According to the European Guideline 2012/19/EU, power tools that are no longer usable, and according to the European Guideline 2006/66/EC, defective or used battery packs/batteries, must be collected separately and disposed of in an environmentally correct manner.

INSTRUCTIONS AND INFORMATION ON DISPOSING OF USED PACKAGING MATERIALS

Put any used package material to the place determined by the municipality for waste disposal.

DISPOSAL OF USED ELECTRIC AND ELECTRONIC EQUIPMENT



This symbol on products or accompanying documents means that used electric or electronic products must not be put to ordinary municipal waste. Hand over such products to determined collection points for proper disposal, restoration and recycling. Alternatively, in some countries of the European Union or other European countries you can return your products to your local dealer when you buy an equivalent new product. By dutiful disposal of this product you can preserve precious natural resources and you help prevent any potential adverse effects on the environment and human health which could be the results of wrong waste disposal. Ask your local authority or the nearest collection point for additional details. In case of improper disposal of this waste kind penalties can be imposed in accordance with national regulations.

For companies in the European Union countries

Should you want to dispose of electric and electronic devices, ask your dealer or vendor for necessary information. Disposal in other countries outside the European Union. Should you want to dispose of this product, ask your local authorities or your dealer for necessary information about disposal method.



This product fulfils all basic requirements of the EU directives that apply to it.

Text, design and technical specifications can change without prior notice and we reserve the right for their change.

User manual in the original language.

10. DECLARATION OF CONFORMITY

FAST[®]

FAST ČR, a.s.
Černokostecká 1621, 251 01 Říčany, Czech Republic
tel.: +420 323 204 111, fax: +420 323 204 110

EU DECLARATION OF CONFORMITY

Product / brand: Cordless pole hedge trimmer / **FIELDMANN**

Type / model: **FZN 70405-0** as factory model D05101300
DC 20V (battery powered), cutting width 420mm, Class III, IPX0
 $L_{pA} = 84dB(A)$, $L_{WA} = 91dB(A)$

Manufacturer: FAST ČR, a.s.
Černokostecká 2111, 100 00 Praha 10, Czech Republic
VAT no: CZ26726548

The product is inline with directives and regulations listed below:

Directive MD 2006/42/EC
Directive EMC 2014/30/EU
Directive NEE 2000/14/EC
Directive RoHS 2011/65/EU

and norms:

EN 62841-1:2015
EN 62841-4-2:2019
EN 55014-1:2017
EN 55014-2:2015



Place of issuance: Prague

Name: Ing. Zdeněk Pech
Chairman of the Board

Date of issuance: 22. 7. 2020

Signature:

FAST[®] FAST ČR, a.s.
Černokostecká 1621, 251 01 Říčany
IČO: 26726548 tel.: +420/ 323 204 111
DIČ: CZ26726548 fax: +420/ 323 204 110

IČO: 26 72 65 48, DIČ: CZ-26 72 65 48

Bankovní spojení: Komerční banka Praha 1, č.ú. 89309011/0100, Česká spořitelna Praha 4, č.ú. 2375682/0800,
ČSOB Praha 1, č.ú. 8010-0116233383/0300