

EN ■ User Manual

CZ ■ Uživatelská příručka

SK ■ Používateľská príručka

HU ■ Felhasználói kézikönyv

PL ■ Podręcznik użytkownika

Weather Station with Wireless Sensor

Meteorologická stanice s bezdrátovým snímačem

Meteorologická stanica s bezdrôtovým snímačom

Meteorológiai állomás vezeték nélküli érzékelővel

Stacja pogodowa z czujnikiem bezprzewodowym

We thank you for the purchase of our Color Display Weather Station. It has been designed and constructed using innovative components and techniques to enable the perfect display by this device. This unit is also equipped with an outdoor sensor. Please read the entire instruction manual before using the product and then save it for future reference. We reserve the right for any errors in text or images and any necessary changes made to technical data.

Things to consider:

1. Other wireless equipment using the same frequency band can reduce the transmission range.
2. The range of all wireless equipment depends on the type of obstacles located between the transmitter and the receiver (e.g. a concrete wall will interfere with the signal much more than a plasterboard wall).

If you experience problems, try the following:

1. Turn off any other existing wireless equipment to check whether this is the cause of the problem.
2. Move any other existing wireless equipment. Shorten the distance between the sending and receiving devices and reduce the number of obstacles(walls, furniture,etc.) between them.
3. Try removing and reassembling batteries, if the batteries are old, try new ones.

SAFETY AND GUIDE

- Do not clean any part of the product with benzene, thinner or other solvent chemicals. If necessary, clean it with a soft cloth.
- Do not dismantle or modify the product in any way.
- Never immerse the product in water, It will damage the product.
- Do not subject the product to extreme force, shock, or fluctuations in temperature or humidity.
- Do not tamper with the internal components.
- Do not use used batteries .
- Do not use different types of batteries alkaline, standard or rechargeable batteries with this product.
- Remove the batteries if storing this product for a long period of time, otherwise the battery might damage the product.
- Do not dispose of this product as unsorted municipal waste, it's necessary to separately collect it for special treatment.
- Do not place the main unit in rain or moisture.The transmit range depends on the type of obstacles located between the transmitter and the receiver (e.g. a concrete wall will interfere with the signal much more than a plasterboard wall).
- Be sure the sensor is mounted vertically, to allow moisture to drain out properly. Place out of direct sunlight & ensure the sensor is well-ventilated.
- The distance between main unit and sensors should be at least 5~ 6.5 feet (1.5~2 meters) away from any interfering sources such as computer monitors or TV sets.
- The main unit stay away from the metal window frames.
- Please do not use other electrical products such as headphones or microphone operating on the same signal frequency. (433.92MHz), neighbors using electrical devices operating on the same signal frequency can also cause interference.
- Place the main unit in a dry area, free of dirt and dust. To ensure accurate temperature measurement, place out of direct sunlight and away from heat sources or vents.

PACKAGE CONTENTS

- 1× Digital Weather Station
- 1× Remote Sensor
- 1× User Manual
- 1× DC Adaptor (Batteries are not included)
- 1× Power Supply

MAIN UNIT INSTALLATION

- Remove the protective film that is applied to the LCD screen prior to using the product.
- Open the battery compartment cover, plugged in with power adapter and use, battery-power is optional, since previous setting will be reset when plugged out, we recommend install the batteries for the base station.
- Base station can stand upright on the table or mount on the wall.

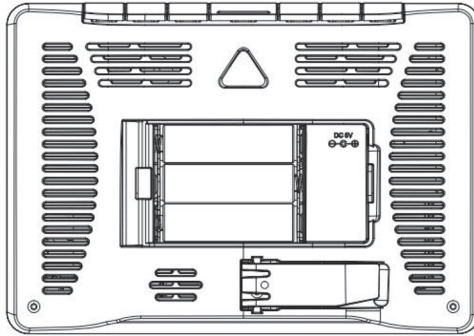

SENSOR INSTALLATION

Base station supports up to 3 sensors connection, the sensor switch is located inside the battery compartment, it can be switched 1,2,3, matching the info of Channel 1, Channel 2, Channel 3 that synchronize on the OUTDOOR position.

1. Remove the battery compartment cover, chose the channel (1,2,3)by switching the channel shift.
2. Insert 2 x AA batteries matching the correct polarity (+ and -), the red led light will flash for once, then assemble the battery compartment.
3. Put the sensor the position you desire.

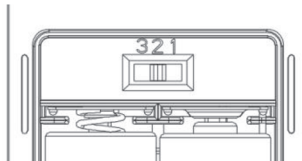

Low Battery Indicator

When battery power for main unit is lower than 3.6V, or when the power for remote sensor is lower than 2.5V, the low battery indicator will display on the LCD.

When it is powered by DC adaptor, the batteries are for memory function. If the low battery indicator for main unit still shows, that means the batteries' power for main unit is lower than 3.6V, please check the batteries situation.

To avoid batteries runs out, getting rotten and damage the units. please change batteries on time when low battery indicator appear.

Please use alkaline dry batteries, do not use rechargeable batteries.

Initialization

1. Install batteries for main unit first, then install batteries for Remote sensor, Plug in the adaptor
 2. After power on, LCD will display full indicator for 3 seconds, and in the meanwhile, temperature sensor and humidity sensor inside will detect indoor temperature & humidity, and then it will start to receive outdoor signal which last for max 3 minutes.
- Time: 24-hour format, June 15, 2022 at 0:00
 - Default language: GER
 - City: BER
 - Date format: D-M
 - Temperature unit: °C
 - Air pressure: hPa mb
 - Time difference: 0 time zone
 - Alarm time: OFF M-F:6:30 S-S: 8:30
 - DST: OFF
 - Default snooze: 5 minutes
 - Weather: cloudy

OVERVIEW

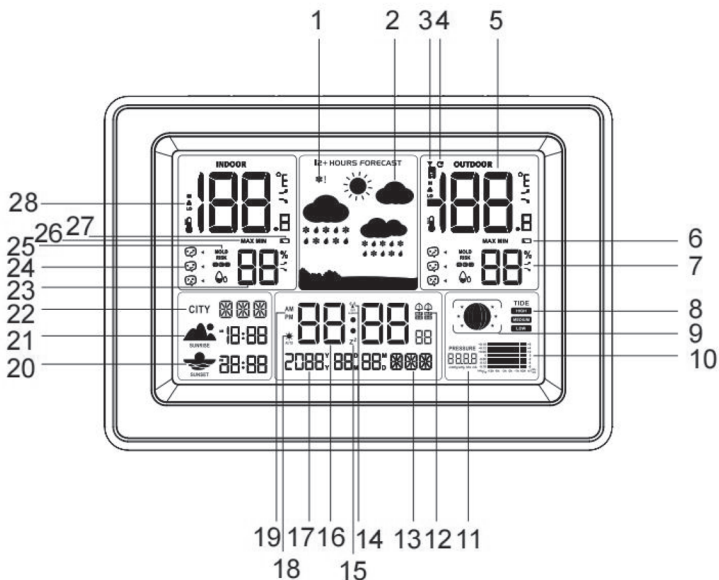

1. Freezing Alert
2. Weather Forecast
3. Sensor Channel
4. Rolling display of 3 channels
5. Outdoor temperature and humidity
6. Low battery Indicator (sensor)
7. Trends for temperature and humidity
8. Tides
9. Moon Phase
10. Barometer Pressure Bar
11. Barometer Pressure Value
12. Alarms
13. Weekday
14. RCC
15. Snooze
16. Time
17. Calendar
18. Auto Dim
19. 12/24 hours
20. Sunset
21. Sunrise
22. City
23. Indoor temperature and humidity
24. Comfortable Indicator
25. Mold Risk Alert
26. Max Min record for outdoor temperature and humidity in 24hours
27. Low battery Indicator(Main Unit)
28. HI &Lo Temperature Alert
29. Hanging Hole

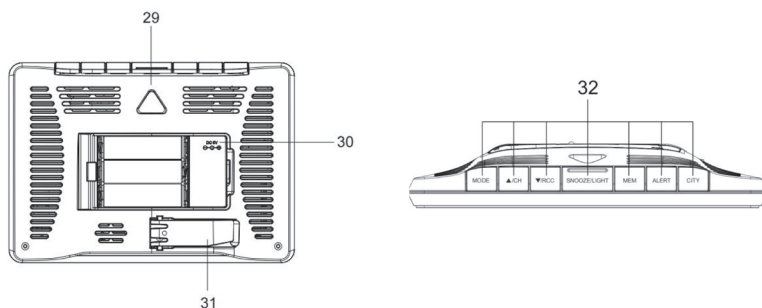

30.DC Jack

31.Stand

32.Buttons: MODE, ▲/CH, ▼/RCC, SNOOZE/LIGHT, MEM, ALERT, CITY

SENSOR

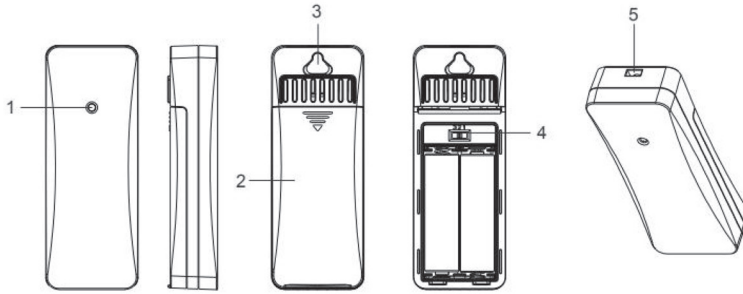

1. LED light
2. Battery compartment Cover
3. Hanging hole
4. Channel shift
5. Rope hanging hole

Waterproofing for daily use, lever: IP54.

When the red led light flash, it is sending signal to main unit.

Be sure our sensor is mounted vertically, to allow moisture to drain out properly. Keep out of direct sunlight & ensure the sensor is well-ventilated.

DC ADAPTOR

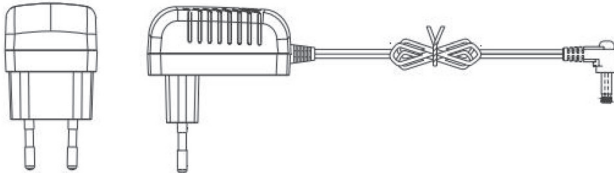

FEATURES

- Weather forecast with 5 status: sunny, partly cloudy, cloudy, rainy, and snowy
- Weekday display in 7 languages
- Freezing Alert Function
- Time and Calendar(Date/Month/Year)
- RCC-DCF automatic time adjustment
- 12/24 hours format switchable
- Dual Alarm with snooze function
- Indoor temperature and humidity
- Outdoor temperature and humidity
- Support up to 3 sensors(1 included)
- Function auto scrolling measured data of all 3 outdoor sensors
- Max/ Min memory records for all indoor and outdoor temperature and humidity
- Comfortable Indicator for all indoor and outdoor temperature and humidity
- Temperature & humidity trend display

- Indoor & Outdoor temperature HI & LO alert (independent setting).
- 150 countries Sunrise/sunset time
- Barometer pressure bar and value display
- Moon Phase & Tide Indicator
- 3-mode brightness: Bright/Dim/Off
- C/F (Celsius/Fahrenheit) switchable
- Max/ Min memory records
- Low battery indicator
- Tone on/off function
- Transmission range: up to 80 meters in open area
- Table standing or wall hanging
- Sensor Transmission Frequency: 433.92 MHz
- Main Unit Power: 3*1.5V type AA (Batteries Not Included) & 5V 1.2A DC Adaptor (Included)
- Sensor Power: 2*1.5V type AA (Batteries Not Included)

BUTTONS FUNCTION

- In standard mode, press the MODE button once to cycle through: time → AL1(M-F) → AL1(S-S) → AL2(M-F) → AL2(S-S)
- In standard mode, press and hold the MODE button for 3 seconds to enter the time setting
- In alarm checking mode, press and hold the MODE button for 3 seconds to enter the alarm setting
- In standard mode, press and hold the ▲/CH button to clear all channel and re-register for reception
- In standard mode, press and hold the ▼/RCC button to manually enter RCC reception, and press again during reception to exit RCC reception.
- In standard mode or RF reception mode, press the ▲/CH button to switch to check different channels
- In time and alarm clock setting mode, single press the ▲/CH button to increase by 1, press and hold to increase by 8 steps per second.
- In time and alarm clock setting mode, single press the ▼/RCC button to decrease by 1, press and hold to decrease by 8 steps per second.
- In standard mode, press the MEM button to view the maximum/minimum temperature and humidity values within 24 hours
- When the maximum and minimum values are displayed, press and hold the MEM button for 3 seconds to clear the maximum and minimum temperature and humidity memory values at the same time.
- In standard mode, press and hold the MEM button for 3 seconds to switch the temperature unit °C/°F
- In standard mode, press the ALERT button to switch among indoor and high and low alarm temperature values for 3 outdoor sensor.
- In standard mode, press and hold the ALERT button to enter the alarm temperature value setting
- In standard mode, press and hold the CITY button for 2 seconds to enter city settings.
- In city setting mode, single press the CITY button to confirm and go to the next letter item
- When the alarm sounds, press the SNOOZE/LIGHT button to enter snooze, and any other button will stop the alarm.
- In DC mode, when the backlight is on, press the SNOOZE/LIGHT button to switch the brightness level.
- In DC mode, when the backlight is on, press and hold the SNOOZE/LIGHT button for 3 seconds to enter the automatic Dim backlight time setting for night.
- In the setting state, press the SNOOZE/LIGHT button to save and exit the setting.
- In battery-powered mode, press any button to highlight the backlight for one minute.

TIME SETTING MODE

- In standard mode, press and hold MODE button for 3 seconds to enter time setting
- The setting item flash at a frequency of 1HZ. Short press the MODE button to select the setting items. The order is: Language →button tone ON/OFF→RCC ON/OFF(ON:ZONE±12HR)→Year→DM/MD→Month→Day→ 12/24HR→Hours→Minutes→Barometric pressure unit→exit
- In time setting mode, when the setting item flashes at 1HZ frequency, short press the UP button to add 1, and press and hold the UP button to quickly add up at 8 steps/second.
- In the time setting mode, when the setting item flashes at a frequency of 1HZ, short press the DOWN button to decrease by 1, and press and hold the DOWN button to quickly decrease at 8 steps/second.
- In time setting mode, if you do not operate for 1minute or press the SNOOZE button during the setting process, you can save the current setting value and exit the time setting.

7 LANGUAGES OF WEEKDAY DISPLAY

Language	German	English	Italian	French	Dutch	Spanish	Denmark
	GER	ENG	ITA	FRE	DUT	SPA	DAN
SUNDAY	SON	SUN	DOM	DIM	ZON	DOM	SON
MONDAY	MON	MON	LUN	LUN	MAA	LUN	MAN
TUESDAY	DIE	TUE	MAR	MAR	DIN	MAR	TIR
WEDNESDAY	MIT	WED	MER	MER	WOE	MIE	ONS
THURSDAY	DON	THU	GIO	JEU	DON	JUE	TOR
FRIDAY	FRE	FRI	VEN	VEN	VRI	VIE	FRE
SATURDAY	SAM	SAT	SAB	SAM	ZAT	SAB	LOR

CITY SET

- In time display mode, press the CITY button to enter the city scrolling selection , press the UP/DOWN button to scroll up/down the city. There is 150cities for choice (please see the city list in the last pages).
- In time display mode, press and hold the CITY button for 2 seconds to enter the city setting. If there is no operation for 1minute, it will return to the time display mode.
- In city setting mode, press the CITY button once to make the first letter of the city flash. Press the ▲/CH button to scroll the letters from A~Z. Press ▼/RCC from Z-A, Then press the CITY button again to confirm and move to the next letter setting.
- After setting the three letters, the sunrise and sunset times will be automatically calculated.
- During the city setting process, the sunrise and sunset positions will display "--:--"
- After confirming and exiting the settings, the sunrise and sunset are being calculated, and the "--:--" will flash.
- When setting a city that is not in the list, after exiting the setting, both the city and sunrise and sunset positions will display "--:--", which means the city is wrong.
- The calendar range is from January 1, 2000 to December 31, 2099.

ALARM SETTING MODE

- In standard mode, single press MODE button to switch to alarm clock display mode
- Single press each time to switch AL1(M-F)'AL1(S-S)'AL2(M-F)'AL2(S-S). then it will return to time display mode after 5 seconds of no operation; snooze time: 5~60 Minutes
- When checking the current alarm, press and hold the MODE button for 3 seconds to enter the current alarm clock settings. Press the MODE button to go to the next setting item. The setting sequence is: ON/OFF→Hour. →Minutes→Snooze time→Exit, when OFF is selected, display turn back to standard time mode.
- When the setting item flashes at 1HZ frequency, short press the ▲/CH button to add 1, and long press the ▲/CH button to quickly add up at 8 steps/second.
- When the setting item flashes at 1HZ frequency, short press the ▼/RCC button to decrease by 1, and long press the ▼/RCC button to quickly decrease at 8 steps/second.
- If there is no operation for 1minute during the setting process, press the MODE button or the SNOOZE button to save the current setting value and exit the alarm clock setting.

ALARM MODE

Alarm time: 2 minutes

Alarm Period: 0-10 seconds: BI once every second

11-20 seconds: BI BI twice per second

21-30 seconds: BI BI BI three times per second

31 seconds-11 minutes: continuous BI BI BI BI beep

- When the alarm sounds, press the SNOOZE/LIGHT button to enter snooze (5~60 minutes). There is no limit to the number of snooze times. Press any other button to stop the alarm.
- In battery-powered mode, the backlight is off by default when the alarm sounds. After pressing the button to stop the alarm, the backlight turns off automatically after one minute.

BACK LIGHT

- When DC powered, backlight brightness is 100%, 60%, 5%, OFF,
- When batteries powered, backlight brightness is 100%
- When DC power supply, after power-on ,the default backlight is 100% bright and always on. press the SNOOZE/LIGHTbutton and the backlight will cycle between high brightness 100%→60%→5%→OFF.
- When Battery-powered, after power-on , the default backlight is 100% on for 1minute. When it is off, press any button to highlight the backlight for 1minute. If there is button operation, the backlight will be on. After the operation is completed, it will delay for 1minute and turn off.

AUTO-DIM BACKLIGHT FOR NIGHT

- The default night auto dim is OFF, backlight period is 22:00~8:00, high brightness is 100%, and low brightness is 5%
- In normal display mode, press and hold the SNOOZE/LIGHT button for 3 seconds to enter the Auto-Dim period setting. Press the SNOOZE/LIGHT button to enter the next setting item.
- The setting sequence is: Auto dim function ON/OFF→Start hour→Start minute→End hour→End minute→Exit



- When the setting item flashes at 1HZ frequency, short press the UP button to add 1, and long press the UP button to quickly add up at 8 steps/second.
- When the setting item flashes at 1HZ frequency, short press the DOWN button to decrease by 1, and long press the DOWN button to quickly decrease at 8 steps/second.
- If there is no operation for 1minute during the setting process, press the MODE button to exit or the SNOOZE button to save the current setting value and exit the automatic backlight time setting.
- When the auto dim function is on, and the time is in the auto dim period, the backlight is with 5% low brightness. When out of auto dim period, it will get back to 100% high brightness automatically.
- When the auto dim function is on, and the time is in the auto dim period, you can freely switch the backlight brightness to different level.
- During the automatic backlight time setting process, single-press the MEM button to clear all saved correction values, and back to default night auto dim as OFF, backlight period is 22:00~8:00).

HI&LO ALERT SETTING

- In the standard time display mode, press the ALERT button to view the alarm temperature setting items of indoor→CH1→CH2→CH3 in sequence, and press and hold for 3 seconds under the current display item.
- ALERT button to enter the current high and low temperature alarm value setting (default OFF, upper limit 35°C, lower limit 10°C)
- In normal display mode, press and hold the ALERT button for 3 seconds to enter the high and low temperature alarm settings. Press the ALERT button to enter the next setting item. The setting sequence is: indoor ON/OFF→
- Indoor high temperature→Indoor low temperature→CH1 ON/OFF→CH1 high temperature→CH1 low temperature→CH2 ON/OFF→CH2 high temperature→CH2 low temperature→CH3 ON/OFF→CH3 high temperature→CH3 Low Temperature→Exit, skip the value setting step when the current item is OFF.
- When the setting item flashes at 1HZ frequency, short press the UP or DOWN button to increase or decrease by 1, and long press the UP button to quickly increase or decrease at 8 steps/second.
- If there is no operation for 20seconds during the setting process, press ALERT to exit or the SNOOZE button to save the current setting value and exit the high and low temperature alarm value setting.
- When the outdoor alarm temperature reaches the set value, the icon and HI (or LO) of the current channel flash, and only the icon of the non-current channel flashes. All three channels have sound prompts.
- When the alarm temperature reaches the set value, the buzzers will sound BIBIBIBI as a group. If there is no button pressed, the buzzer will sound in one group every minute until it exits the alarm temperature range. When the alarm occurs,
- If any button is pressed, the sound will stop alarming, and the icon will still flash at a frequency of 1HZ until it exits the alarm range.
- During the indoor and outdoor high and low temperature warning setting process, press the MEM button to clear all saved setting values (default as off)

INDOOR/OUTDOOR TEMPERATURE AND HUMIDITY AND TREND

Indoor temperature range:-9.9°C~50°C
Outdoor temperature range:-40°C~60°C
LL.L & HH.H will display when out of range

Indoor/outdoor humidity detection range: 1% to 99%;
if it is higher than 99%, it will display 99%, if it is lower than 1%, it will display 1%

2.Trends:

Trends Icon will not display at the moment of powering on.

- The trend ↗ will display, when the temperature increase 1°C compared to last data, or increase 1 °C in 1 hour;
- The trend ↘ will display, when the humidity value increase 5% compared to last data, or increase 5% in 1 hour vice the verse for decrease trends.

when the increase/decrease is less then 1°C or 5% in 1 hour, no trend icon will display.

MEMORY

Under normal time displaying mode, press 【MEM】 button to check the 3 channel indoor and outdoor temperature and humidity, the record sequence is :Indoor/outdoor maximum temperature&humidity→Indoor/outdoor minimum temperature&humidity. No operation in 6 seconds,it will return to current temperature &humidity display.

Max/Min:

The maximum/minimum records will be cleared automatically at 00:00 everyday. Or manually clear the max/min record by holding 【MEM】 at Time Display mode. It will clear the record, display - -, and then display the current value.

ATMOSPHERIC PRESSURE

3 UNITS for choice: hPa/mb, inHg, mmHg

Range: 850-1050 hPa

Atmospheric pressure is updated and tested every hour, and the air pressure bar is updated at the same time

Record the atmospheric pressure value in the past 1, 2, 3, 6, and 12 hours, and compare it with the current pressure value to form a trend bar and display it.

From right to left, one column is displayed every second, and the dynamic display is continuously cycled.

MOLD RISK WARNING



There are 3 levels of mold risk warning: LO, ME and HI, when the level of mold risk warning is LO or ME, the symbol display all the time. When the level is HI, the symbol "HI" flashes.

Temperature range	No Risk	Low Risk	Medium Risk	High Risk
display	no display	LO display	ME display	HI flashes 1 time per second
<11.0°C	Any humidity value			
11.0°C~25.9°C	Humidity≤48	49≤humidity≤78	79≤Humidity	
26.0°C~30.9°C		Humidity=78	79≤Humidity≤87	88≤Humidity
31.0°C~40.9°C		Humidity=48	49≤Humidity≤87	88≤Humidity
≥41.0°C	Any humidity value			

COMFORT LEVEL INDEX



Comfort level displays with 3 status: DRY, GOOD, WET

For outdoor sensors

Comfort Level		Humidity Range
Dry		1-39%
Good		40-70%
Wet		≥ 71%

For main unit

It is calculated with both temperature and humidity, with value SSD

Comfort Level		SSD
Dry		< 50
Good		50-71
Wet		> 71%

FROST ALERT

- When the outdoor display temperature of the current RF channel is within the range of 0~2.9°C, the frost point alarm symbol “❄️” flashes;
- when temperature of the outdoor channel is lower than 0°C, the frost and snow symbol “❄️” displays all the time;
- when temperature is higher than 2.9°C the freezing point symbol “❄️” disappear.

MOON PHASE

MOON PHASE displays the moon phase level, and the moon phase level is divided into 12 levels, as shown in the figure below.

It will display automatically once the unit receives or set with date information.

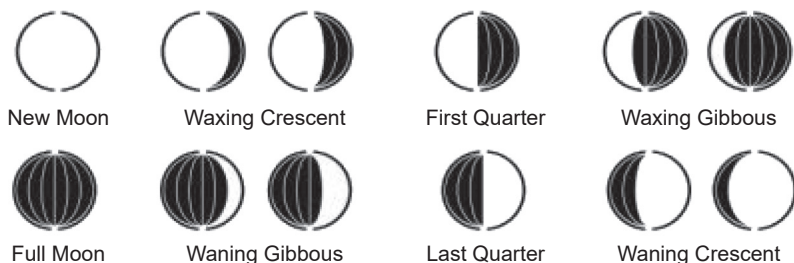

WEATHER FORECAST

WEATHER ICON					
Description	Sunny	Partly Cloudy	Cloudy	Rainy	Snowy

- Weather forecast in 12+ Hour: Sunny, Partly Cloudy, Cloudy, Rainy, Snowy
- The weather icon displays are based on the hourly calculation of indoor/outdoor temperature & humidity. The forecast station predict weather conditions for the next 12 hours with 70-75% accuracy. The remote sensor should be put on the outside to have accurate outdoor data. Or it will effect the accurate of weather forecast.
- The default display weather is partly cloudy, the main unit will calibrate the weather report in 1-2 weeks with the temperature and humidity data changes.
- The remote sensor should be place outside to get accurate outdoor data or it will effect the accurate of weather forecast.

RF-OUTDOOR TERPERATURE AND HUMIDITY

After the power is turned on, main unit is powered on or reset, if all three channels receive signals within 3-minute reception time, the reception will close immediately, as long as there is still one channel that has not received successfully, the RF receiving mark is still flashing. During long-term reception, the RF signal sign “📶” flashes at a frequency of 1Hz. After the RF signal is successfully received, the symbol “📶” will be displayed all the time.

If the receiver only receives 1 or 2 channels within 3 minutes, the channel that does not receive a signal will no longer be automatically opened for reception in the future, and only the channel that has been paired and registered will be received, unless it is powered on again, reset or manually forced pairing to receive all channels.

CHANNEL & SENSOR OPERATION

1. The weather station supports max connection with up to 3 sensors.
2. Remove the battery cover of sensor and slide CH switch to CH1/CH2/CH3, make sure each sensor is assigned to a different CHANNEL number.
3. It is recommended to put CH1 sensor in outdoor for more accurate weather forecast, and put other sensors in your desired area.
4. In standard mode, Press **【▲/CH】** button to check the outdoor temperature and humidity of channel 1/2/3. When you switch to the mode, the display will automatically loop 3 sensor' data. If you want to reset all the data of sensors, press and hold **【▲/CH】** button 3 seconds, and it will reconnect with the sensors.

Note:

When there is a conflict between RF, RCC and alarm sound, the priority order is: Alarm → RCC → RF
When the RF is on reception for 3 minutes, it is interrupted by RCC or interrupted by an alarm. After the RCC reception is completed or the alarm is completed, the RF is turned on again for 3 minutes.

RCC FUNCTION

- During Time setting, if RCC is set OFF, the RCC function is turned off permanently, until it is set ON again.
- After power-on or reset, it will automatically enters the RCC receiving mode. The triangular tower symbol ▲ displays and flashes at a frequency of 1Hz. If there is a connection during RCC reception,
- After receiving a valid signal, the triangular tower symbol ▲ displays statically, and the signal wave symbol (⌚) flashes at a frequency of 1Hz. If the signal is received during valid reception,
- If the signal is suddenly interrupted, the signal wave symbol (⌚) will not display, and the triangular tower symbol ▲ will be displays and flash until a valid signal is received again.
- Switch to the previously valid display mode
- The RCC reception time is 7 minutes. If the RCC reception is successful within 7 minutes, the time displays on the unit the reception will be exited immediately and the RCC symbol (▲) will displays all the time, indicating that the RCC reception is successful.
- Automatically receive RCC function: Regardless of whether the RCC signal is received or not, it will automatically enter the RCC reception at 1:00, 2:00, 3:00, 4:00, and 5:00 every morning. The unit will receive signal on 1:00, 2:00 and 3:00, if 3:00 is not received successfully, the receiving is turned on in turn, as long as there is 1 successful reception. If it succeeds, the receiving will not be turned on for the next few times, no matter whether the receiving is successful or not.
- In standard mode, press and hold the ▼/RCC button for 3 seconds to manually enter the RCC receiving mode. Press the ▼/RCC button again to exit reception.
- If there is no reception within 7 minutes, it will automatically exit RCC reception and continue to run at the original time, and then every 3 hours at 0:00, 3:00, 6:00, 9:00, 12:00, 15:00, 18:00, 21:00 automatically RCC reception will be turn on. It does not follow the early morning reception rules. As long as the reception is successful once, it will become the early morning reception rules.
- When the time zone setting is not 0, the time will automatically changes with the time zone.
- When there is a conflict between RF, RCC the priority order is RCC → RF
- When the RF reception is interrupted by RCC. It will be turn on again after the RCC reception is completed.

Adapter technical specifications:	
Manufacturer's name or trade mark, commercial registration number and address:	DONGGUAN SHIJIE HUAXU ELECTRONICS FACTORY, Commercial Registration Number: 440429543, Address: No.200, Technology East Road ,Shijie TownDongguan City,Guangdong, P.R.China
Model identifier:	HX075-0501200-AG-001
Input voltage:	AC100 - 240V
Input AC frequency:	50/60Hz
Output voltage:	DC5.0V
Output current:	1.2A
Output power:	6.0W
Average active efficiency:	≥75.00%
Efficiency at low load (10 %):	71.17%
No-load power consumption:	≤0.1W

150 Cities for Sunrise and Sunset

	Country	CITY	Abbr.
1	Germany	Aachen	AAC
2	Germany	Berlin	BER
3	Germany	Dusseldorf	DUS
4	Germany	Dresden	DRE
5	Germany	Erfurt	ERF
6	Germany	Frankfurt	FRA
7	Germany	Flensburg	FLE
8	Germany	Freiburg	FRE
9	Germany	Hannover	HAN
10	Germany	Bremen	BRM
11	Germany	Hamburg	HAM
12	Germany	Rostock	ROS
13	Germany	Stralsund	STR
14	Germany	Cologne	COL
15	Germany	Kiel	KIE
16	Germany	Kassel	KAS
17	Germany	Leipzig	LPZ
18	Germany	Munich	MNI
19	Germany	Magdeburg	MAG
20	Germany	Nuremberg	NUR
21	Germany	Regensburg	REG
22	Germany	Stuttgart	STU

	Country	CITY	Abbr.
23	Germany	Saarbrücken	SAA
24	Germany	Schwerin	SCH
25	Denmark	Aalborg	ALB
26	Denmark	Aarhus	ARH
27	Denmark	Copenhagen	COP
28	Denmark	Odense	ODE
29	Spain	Alicante	ALI
30	Spain	Andorra	AND
31	Spain	Badajoz	BAD
32	Spain	Barcelona	BAR
33	Spain	Bilbao	BIL
34	Spain	Cadiz	CAD
35	Spain	Cordoba	COR
36	Spain	Ibiza	IBI
37	Spain	A Coruna	ACO
38	Spain	Leon	LEO
39	Spain	Las Palmas	LPA
40	Spain	Madrid	MAD
41	Spain	Malaga	MAL
42	Spain	Palma(ES-Majorca)	PLM
43	Spain	Salamanca	SAL
44	Spain	Sevilla	SEV
45	Spain	Valencia	VAL
46	Spain	Zaragoza	ZAR
47	France	Besancon	BES
48	France	Biarritz	BIA
49	France	Bordeaux	BOR
50	France	Brest	BRE
51	France	Cherbourg	CHE
52	France	Lyon	LYO
53	France	Marseille	MAR
54	France	Monaco	MON
55	France	Metz	MET
56	France	Nantes	NAN
57	France	Nice	NIC
58	France	Orleans	ORL

	Country	CITY	Abbr.
59	France	Paris	PAR
60	France	Perpignan	PPA
61	France	Lille	LIL
62	France	Rouen	ROU
63	France	Strasbourg	STB
64	France	Toulouse	TOU
65	Finland	Helsinki	HEL
66	U.K.	Aberdeen	ABD
67	U.K.	Belfast	BEL
68	U.K.	Birmingham	BIR
69	U.K.	Bristol	BRI
70	U.K.	Edinburgh	EDI
71	U.K.	Glasgow	GLA
72	U.K.	London	LON
73	U.K.	Manchester	MAN
74	U.K.	Plymouth	PLY
75	Hungary	Budapest	BUD
76	Croatia	Zagreb	ZAG
77	Italy	Ancona	ANC
78	Italy	Bari	BAI
79	Italy	Bologna	BOL
80	Italy	Cagliari	CAG
81	Italy	Catania	CAT
82	Italy	Firenze	FIR
83	Italy	Foggia	FOG
84	Italy	Genoa	GEN
85	Italy	Lecce	LEC
86	Italy	Messina	MES
87	Italy	Milan	MIL
88	Italy	Naples	NAP
89	Italy	Palermo	PAL
90	Italy	Parma	PRM
91	Italy	Perugia	PER
92	Italy	Rome	ROM
93	Italy	Turin	TUR
94	Italy	Trieste	TRI

	Country	CITY	Abbr.
95	Italy	Venice	VEN
96	Italy	Verona	VER
97	Italy	Imperia	IMP
98	Ireland	Dublin	DUB
99	Duchy of Luxembourg	Luxemburg	LUX
100	Norway	Bergen	BRG
101	Norway	Oslo	OSL
102	Norway	Stavanger	STA
103	Netherlands	Amsterdam	AMS
104	Netherlands	Eindhoven	EIN
105	Netherlands	Enschede	ENS
106	Netherlands	Groningen	GRO
107	Netherlands	The Hague	HAG
108	Netherlands	Rotterdam	ROT
109	Portugal	Evora	EVO
110	Portugal	Coimbra	COI
111	Portugal	Faro	FAR
112	Portugal	Leiria	LEI
113	Portugal	Lisbon	LIS
114	Portugal	Porto	POR
115	Poland	Gdansk	GDA
116	Poland	Krakow	KRA
117	Poland	Poznan	POZ
118	Poland	Szczecin	SZC
119	Poland	Warsaw	WAR
120	Russia	St Petersburg	PET
121	Sweden	Gothenburg	GOT
122	Sweden	Stockholm	STO
123	Slovakia	Bratislava	BRV
124	slovenia	Ljubljana	LJU
125	Serbia	Belgrade	BGD
126	Austria	Graz	GRZ
127	Austria	Innsbruck	INN
128	Austria	Linz	LIN
129	Austria	Salzburg	SZB
130	Austria	Vienna	VIE

	Country	CITY	Abbr.
131	Belgium	Antwerp	ANT
132	Belgium	Bruges	BRU
133	Belgium	Brussels	BRS
134	Belgium	Charleroi	CHA
135	Belgium	Liege	LIE
136	Switzerland	Basel	BAS
137	Switzerland	Bern	BEN
138	Switzerland	Chur	CHU
139	Switzerland	Geneva	GNV
140	Switzerland	Locarno	LOC
141	Switzerland	Lucerne	LUC
142	Switzerland	St.Moritz	MOR
143	Switzerland	St.Gallen	GAL
144	Switzerland	Sion	SIO
145	Switzerland	Vaduz	VAD
146	Switzerland	Zurich	ZUR
147	Czech Republic	Prague	PRA
148	Greece	Athens	ATH
149	Romania	Bucharest	BUC
150	Bulgaria	Sofia	SOF

PRECAUTIONS

- Do not clean any part of the product with benzene, thinner or other solvent chemicals. When necessary, clean it with a soft cloth.
- Never immerse the product in water. This will damage the product.
- Do not subject the product to extreme force, shock, or fluctuations in temperature or humidity.
- Do not tamper with the internal components.
- Do not mix new and old batteries or batteries of different types.
- Do not mix alkaline, standard or rechargeable batteries with this product.
- Remove the batteries if storing this product for a long period of time.
- Do not dispose of this product as unsorted municipal waste. Collection of such waste separately for special treatment is necessary.

TECHNICAL SPECIFICATIONS

Weather Forecast Icon (Sunny, Partly Cloudy, Cloudy, Rainy, Thunderstorm, Snowy)
12 ~ 24 Hour Forecast Based on Changing Air Pressure and Temperature
Indoor Temperature and Humidity Reading with Comfort and Trend Indicator
Outdoor Temperature and Humidity Reading with Trend Indicator
Radio Controlled Clock by Signal DCF77 (Manual Setting Possible)
Barometric Pressure Value
Bar Chart for Pressure Changes (-1, -2, -3, -6, -12 hours)
Digital Time, Date and Weekday
Moon Phase, Tide Indicator
Sunrise / Sunset Time
Comfort Level Indication (3 Levels)
Mold Risk Alert (3 Levels)
Outdoor Temperature High / Low Alert Function
Frost Alert for Outdoor Channel
Max / Min Memory Records (24 h)
Snooze Function, Dual Alarm
Indoor Temperature Range: -10°C to +50°C
Outdoor Temperature Range: - 40°C to +60°C
Indoor and Outdoor Humidity Range: 1% to 95% RH
12 / 24 Hours Selectable Format
Temperature Display with °C / °F Selectable
3 Level Display Brightness: Hi / Lo / Off
Desktop or Wall Mountable
Low Battery Indicators (for Main Unit and Outdoor Sensor)
Support up to 3 Sensors
Function Auto Scrolling Measured Data of All Three Outdoor Sensors
1 Sensor Included (SWS TH3600-4500-4900)
Transmission Between Main Unit and Sensor up to 80 m (in Open Area)
Sensor Transmission Frequency: 433.92 MHz
Power Adaptor of Main Unit: DC 5 V / 1200 mA (Included), Consumption: 6 W
Battery Back-Up of Main Unit: 3 x 1,5 V Type AA (Batteries Not Included)
Power of Sensor: 2 x 1.5 V Type AA (Batteries Not Included)
Dimensions of Main Unit: (w / h / d) 175 x 123 x 30 mm
Weight of Main Unit: 236 g

INSTRUCTIONS AND INFORMATION ON THE DISPOSAL OF DISCARDED PACKAGING MATERIALS

Take the packaging material to a collection yard for disposal.

DISPOSAL OF DISCARDED ELECTRICAL AND ELECTRONIC EQUIPMENT



This symbol on the product, accessory or packaging indicates that the product must not be treated as normal household waste. Please dispose of this product in a collection yard designated for the recycling of electrical and electronic equipment. In some EU countries or in some European countries, you can return your products to your local retailer when you buy an equivalent new product. Correct disposal of this product helps save valuable natural resources and prevents possible adverse impacts on the environment and human health that might be caused by improper waste disposal. Please contact your local authority or the nearest waste collection yard for further details. Improper disposal of this type of waste may be subject to a legal fine.

For companies in the European Union

If you need to dispose of electrical or electronic equipment, ask your dealer or supplier for the necessary information.

Disposal in countries outside the European Union

To dispose of this product, please ask your local authorities or dealer for the necessary information on correct disposal.



This product complies with EU requirements.

FAST ČR, a. s. hereby declares that the radio device type SWS 4500 complies with Directive 2014/53/EU. For full version of the EU declaration of conformity, please refer to the website: www.sencor.cz

Changes in the text, design and technical specifications may be made without prior notice and we reserve the right to make such changes.

The original version is in Czech.

Manufacturer: FAST ČR, a.s., U Sanitasu 1621, Říčany 251 01, Czech Republic

Authorized service centers: Visit www.sencor.com for detailed information about authorized service centers.

SENCOR®

EN Warranty conditions

Warranty card is not a part of the device packaging.

This product is warranted for the period of 24 months from the date of purchase to the end-user. Warranty is limited to the following conditions. Warranty is referred only to the customer goods using for common domestic use. The claim for service can be applied either at dealer's shop where the product was bought, or at below mentioned authorized service shops. The end-user is obligated to set up a claim immediately when the defects appeared but only till the end of warranty period. The end user is obligated to cooperate to certify the claiming defects. Only completed and clean (according to hygienic standards) product will be accepted. In case of eligible warranty claim the warranty period will be prolonged by the period from the date of claim application till the date of taking over the product by end-user, or the date the end-user is obligated to take it over. To obtain the service under this warranty, end-user is obligated to certify his claim with duly completed following documents: receipt, certificate of warranty, certificate of installation.

This warranty is void especially if apply as follows:

- Defects which were put on sale.
- Wear-out or damage caused by common use.
- The product was damaged by unprofessional or wrong installation, used in contrary to the applicable instruction manual, used in contrary to legal enactment and common process of use or used for another purpose which has been designed for.
- The product was damaged by uncared-for or insufficient maintenance.
- The product was damaged by dirt, accident of force majeure (natural disaster, fire, and flood).
- Defects on functionality caused by low duality of signal, electromagnetic field interference etc.
- The product was mechanically damaged (e.g. broken button, fall).
- Damage caused by use of unsuitable media, fillings, expendable supplies (batteries) or by unsuitable working conditions (e.g. high temperatures, high humidity, quakes).
- Repair, modification or other failure action to the product by unauthorized person.
- End-user did not prove enough his right to claim (time and place of purchase).
- Data on presented documents differs from data on products.
- Cases when the claiming product cannot be indentified according to the presented documents (e.g. the serial number or the warranty seal has been damaged).

Manufacturer:

FAST ČR, a.s., U Sanitasy 1621, Říčany 251 01, Czech Republic

Visit www.sencor.com for detailed information about authorized service centers.

The original version of the instructions is in the Czech language, other language versions are made by the appropriate translation.

